

Standard Cylinder Series SZ 250

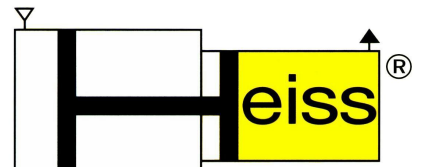

HYDRAULIK + PNEUMATIK GMBH

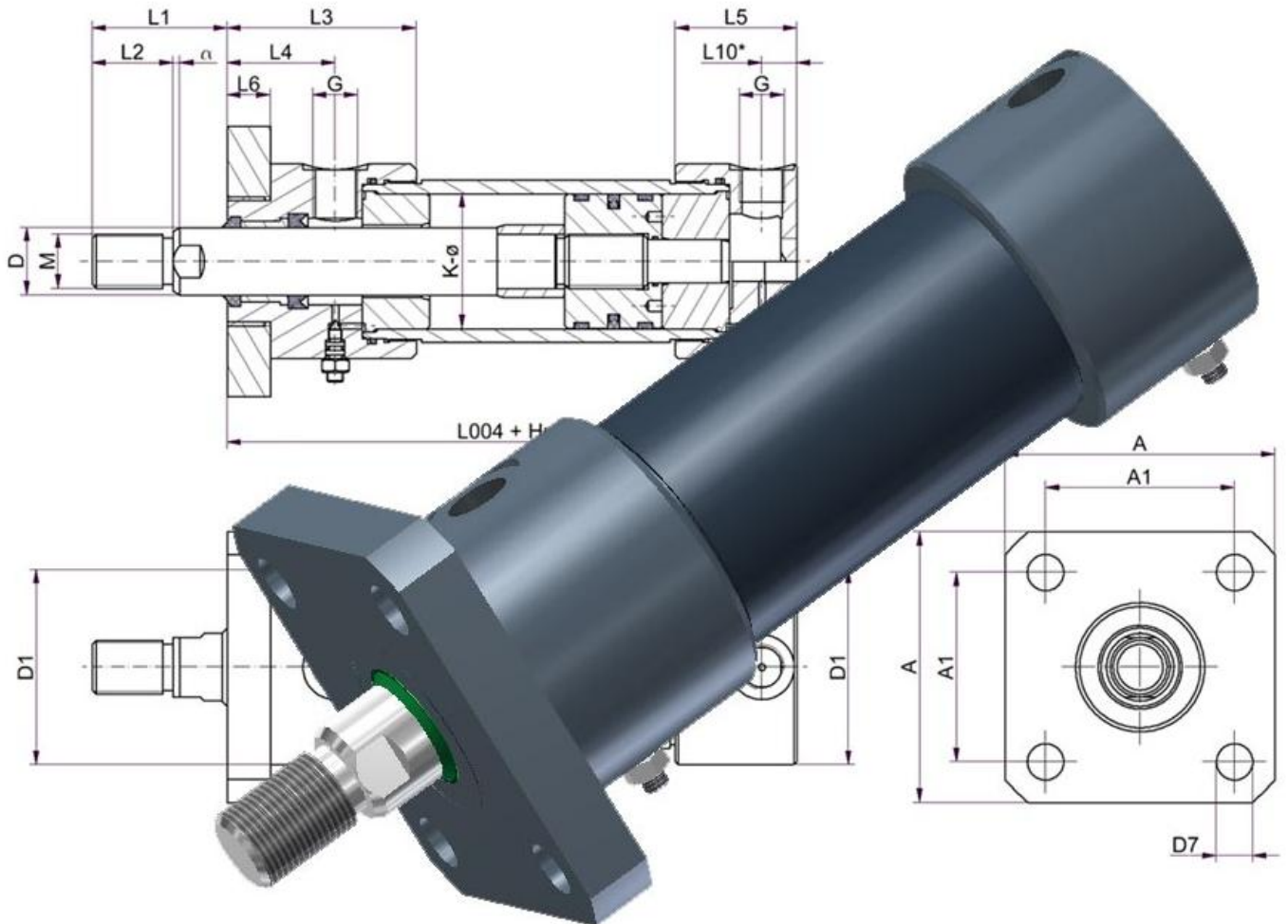

- Maximum operating pressure up to 250 bar
- Choice of 12 different piston sizes between 16 and 200mm and 23 different attachments
- Rugged yet compact round shape design with good guiding properties
- Seal arrangement for easy service
- Seal groove and diameter according to ISO 5597/1 and DIN ISO 7425/1
- Seals by default for maximum continuous duty temperatures $\leq 80^{\circ}\text{C}$ and velocities $\leq 0,5 \text{ m/s}$
- Available for use with water

Inhaltsverzeichnis:

General information / Technical specifications	2
Overview of attachment methods	3
Overview of functional modes	6
Dimension data sheets of configurations	7
Piston force diagram	30
Load/buckling diagram	31
Type designation	32

General information:

The cylinders are manufactured for the below listed applications in threaded design with ground and hard-chrome plated cylinder rods.

Special purpose designs of almost any kind can be considered. Intermediate sizes or piston sizes up to 500mm diameter are possible.

Cylinders can be fitted with vent valves upon request. Please indicate the desired location for the vent when ordering.

Please request our electronic product catalogue for CAD data or download it from www.heiss.de.

Technical specifications:

Operating pressure:

Maximum 250 bar, for higher operating pressures please contact us.

Operating fluids:

Hydraulic oil on the basis of mineral oils for example H, HL, HLP-oils per DIN 51524/51525. Other operating fluids like fire resisting fluids or water are possible upon request.

Operating temperature:

By default the cylinder is fitted with seals for a temperature range from -20°C to +80°C. High temperature resistant seals can be fitted without changes in design.

Piston travel speed:

Maximum 0,5 m/s. Please contact us for higher piston travel speeds.

Cylinder stroke:

The maximum permissible stroke is dependent on the permissible buckling stress. For dimensioning help please use the load/buckling diagram with the simplified calculation formulas.

Position of connections:

By default the bottom ports are concentric except with configurations 111-2, 116, 117, 118 to 225. Should the port be positioned radially please indicate this with the order.

Cylinders with dampers have the adjustment screw positioned across the port (Pos. 3) except with configuration 113, 113-1 and 113-2, here the adjustment screw is rotated by 90° away from the port when looking at the face of the piston rod end (Pos. 2).

Pos. 1 is the port position for all configurations. Should a different port position be required please indicate this with the order.

Example in combination with various attachments:

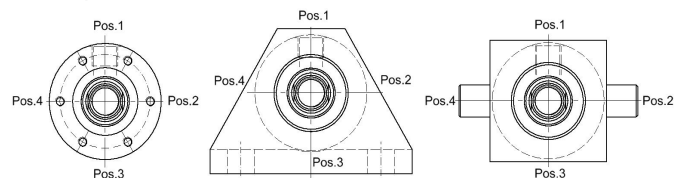

For port position rotated by 90° in clockwise direction please indicate with order "hydraulic port in Pos. 2".

Tolerances:

Tolerances for stroke and stroke dependent dimensions according to DIN ISO 2768 - g T1 (previously DIN 7168 - g)

Other tolerances according to DIN ISO 2768 - m T1 (previously DIN 7168 - m)

Attachment elements:

Swivel heads, rod clevis and rod end straight eyes as well as pivot brackets and pillow blocks for pivot pin attachments can be found in our main catalogue under Accessories.

Position sensing:

Three ways for position sensing are available:

- Pressure resistant inductive proximity switches for end-of-stroke polling.
- Magnetic field sensors for additional sensing of intermediate positions. (The cylinder length increases. If required please contact us.)
- Position measuring systems with various output signals for position measuring.

Technical specifications about end position sensing and position encoders can be found in our respective standard catalogue pages.

Attachment methods

Standard cylinder series SZ250



		Order No.	Description
		110	BASIC ATTACHMENT Clamping possible on cylinder tube
		110-1	BASIC ATTACHMENT With metric fine thread and grooved nut on cylinder tube (limited to strokes of up to 100 mm)
		111	THREAD ATTACHMENT With male thread on cylinder head
		111-1	THREAD ATTACHMENT Centering shoulder and threaded holes on the face of the cylinder head
		111-2	THREAD ATTACHMENT Centering shoulder and threaded holes on the face of the cylinder bottom
		112	FLANGE ATTACHMENT On front of cylinder head with 4 bolt holes
		112-1	FLANGE ATTACHMENT On back of cylinder head with 4 bolt holes
		113	FOOT ATTACHMENT Tangential foot screwed onto cylinder tube

Design subject to change

Revision B * 15.11.1996 *K.E.

Attachment methods

Standard cylinder series SZ250



Order No. Description

	<p>113-1</p>	<p>FOOT ATTACHMENT Angled foot screwed onto cylinder head</p>
	<p>113-2</p>	<p>FOOT ATTACHMENT Angled foot screwed onto cylinder head and angled foot shiftable along cylinder tube</p>
	<p>114</p>	<p>PIVOT PIN ATTACHMENT At front end of cylinder head</p>
	<p>114-1</p>	<p>PIVOT PIN ATTACHMENT At back end of cylinder head</p>
	<p>115</p>	<p>PIVOT PIN ATTACHMENT On cylinder tube, position adjustable</p>
	<p>116</p>	<p>PIVOT PIN ATTACHMENT At cylinder bottom (pivot pins removable)</p>
	<p>117</p>	<p>FLANGE ATTACHMENT At cylinder bottom with 4 bolt holes</p>
<p>View A:</p>	<p>118</p>	<p>PIVOT EYE ATTACHMENT With bronze bushing at cylinder bottom</p>

Design subject to change

Revision B * 15.11.1996 *K.E.

Attachment methods

Standard cylinder series SZ250



	Order No.	Description
<p>View A:</p>	218	PIVOT EYE ATTACHMENT With bronze bushings both ends
<p>View A:</p>	119	PIVOT EYE ATTACHMENT With ball and socket joint at cylinder bottom
<p>View A:</p>	219	PIVOT EYE ATTACHMENT With ball and socket joints both ends
	120	NONDIFFERENTIAL CYLINDER Piston rod both sides, with thread attachment 111*)
	120-1	NONDIFFERENTIAL CYLINDER With stroke adjustment Piston rod both sides, with thread attachment 111*)
<p>View A:</p>	125	CLEVIS ATTACHMENT Clevis bracket at cylinder bottom
<p>View A:</p>	225	CLEVIS ATTACHMENT Both ends (clevis bracket at cylinder bottom and rod clevis at rod end)

Design subject to change

Revision B * 15.11.1996 *K.E.

*) ... can be combined with other attachment modes

- Other attachment combination available upon request -

Functional modes

Standard cylinder series SZ250



Symbol per DIN 24300	Identifier	Description
	001	Single acting, works pushing, return run requires outside force
	002	Single acting, works pulling, return run requires outside force
	003	Double acting
	004	Double acting, adjustable end-of-stroke damper on both sides
	005	Double acting, adjustable end-of-stroke damper on rod side
	006	Double acting, adjustable end-of-stroke damper on bottom side
	120.003	Double acting nondifferential cylinder
	120.004	Double acting nondifferential cylinder, adjustable end-of-stroke damper on both sides
	120.005	Double acting nondifferent cylinder, adjustble end-of-stroke damper on one side
Special functional modes		
	001-F	Single acting, works pushing, return run actuated by spring
	002-F	Single acting, works pulling, return run actuated by spring
	001	Plunger cylinder single acting, works pushing.
	003-T	Double acting tandem cylinder (high piston forces at small outside-Ø)

Design subject to change

Revision B * 15.11.1996 *K.E.

Standard cylinder series SZ 250

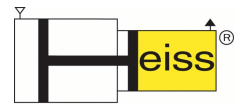

Configuration 110

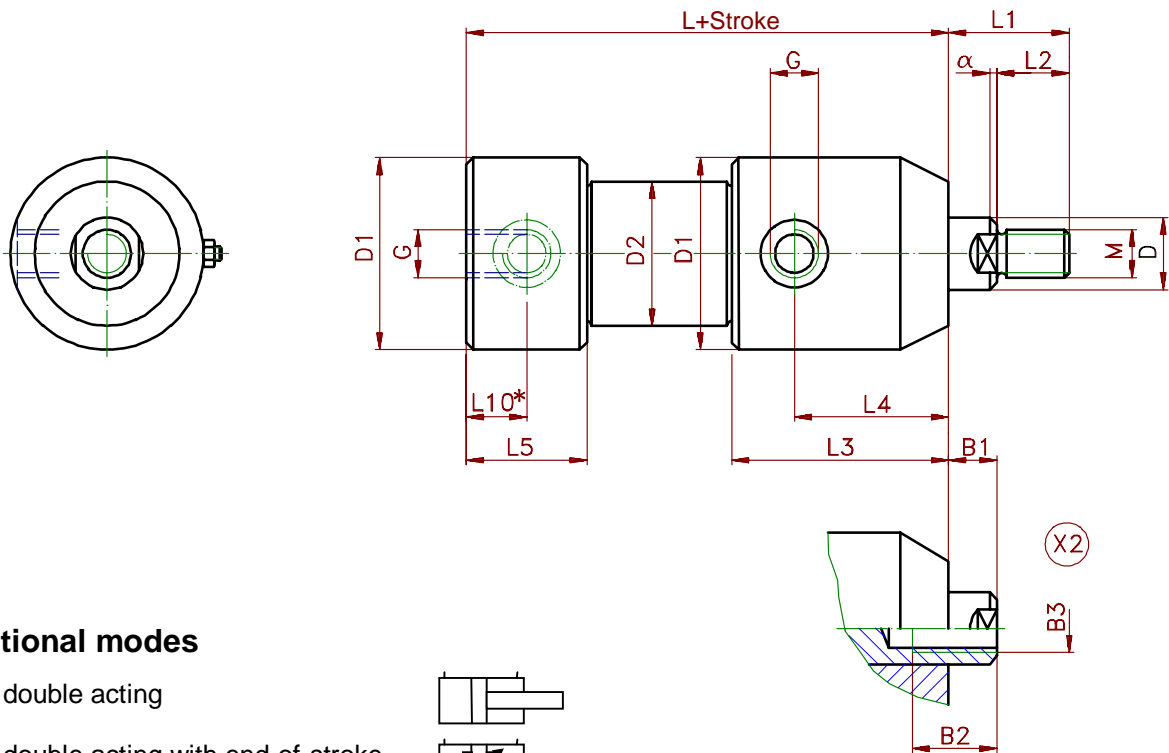

Functional modes

003 = double acting

004 = double acting with end-of-stroke damper both sides

005 = double acting with end-of stroke damper on rod side

006 = double acting with end-of-stroke damper on bottom side

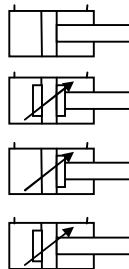

Piston rod end with female thread
Indicate required size when ordering
Or according to customers drawing

L10* only if radial port at bottom requested (indicate with cylinder order) !

Piston-ø	16	20	25	32	40	50	63	80	100	125	160	200
D rod ø	10	12	16	20	25	32	40	50	60	80	100	125
M	M8	M10	M14	M16	M20x1,5	M24x2	M30x2	M35x1,5	M45x1,5	M58x1,5	M80x2	M110x2
D1	32	37	45	50	64	75	95	115	140	180	225	280
D2	22	25	30	38	48	60	75	92	115	145	190	245
L 003	64	84	100	110	118	132	157	172	184	232	300	340
L 004	84	114	140	150	158	182	207	232	254	312	400	460
L 005/006	74	99	120	130	138	157	182	202	219	272	350	400
L1	20	25	31	37	43	50	53	73	85	88	110	150
L2	12	15	20	22	25	30	33	48	60	58	80	110
L3	46	61	72	75	82	88	115	132	140	175	220	240
L4	23	35	44	45	49	52	70	84	92	113	145	145
L5	30	38	39	46	47	52	62	67	67	85	100	120
L10*	8	11	11	13	13	15	16	18	18	20	25	25
G	G1/8"	G1/8"	G1/4"	G1/4"	G3/8"	G1/2"	G1/2"	G1/2"	G1/2"	G3/4"	G1"	G1"
α	1x30°	1,5x30°	1,5x30°	2x30°	2x30°	2,5x30°	3x30°	3x30°	3x30°	4x30°	5x30°	6x30°

Design subject to change

Revision B * 15.11.1996 *K.E.

Standard cylinder series SZ 250



Configuration 110-1

- for stroke ranges up to 100 mm -

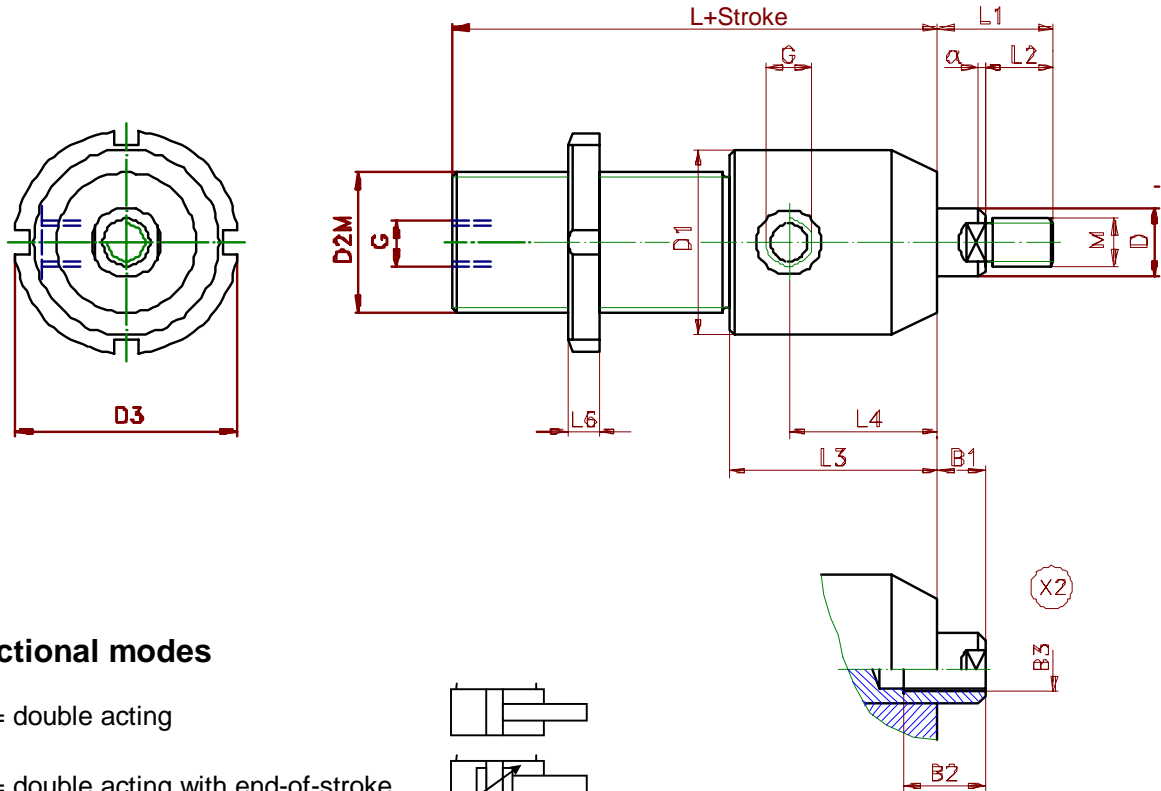

Functional modes

003 = double acting

004 = double acting with end-of-stroke damper on both sides

005 = double acting with end-of-stroke damper on rod side

006 = double acting with end-of-stroke damper on bottom side

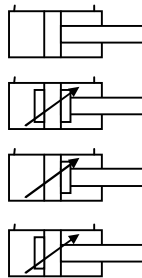

Piston rod end with female thread
Indicate required size when ordering
Or according to customers drawing

Piston-ø	16	20	25	32	40	50	63	80	100	125	160	200
D rod ø	10	12	16	20	25	32	40	50	60	80	100	125
M	M8	M10	M14	M16	M20x1,5	M24x2	M30x2	M35x1,5	M45x1,5	M58x1,5	M80x2	M110x2
D1	32	37	45	50	64	75	95	115	140	180	225	280
D2M	M20x1	M30x1	M35x1,5	M40x1,5	M55x2	M65x2	M80x2	M100x2	M125x2	M160x3	M205x3	M260x4
D3	32	45	52	58	75	85	105	130	160	210	250	330
L 003	64	82	96	105	117	130	150	170	182	257	340	380
L 004	84	112	136	145	157	180	200	230	252	337	440	500
L 005/006	74	97	116	125	137	155	175	200	217	297	390	440
L1	20	25	31	37	43	50	53	73	85	88	110	150
L2	12	15	20	22	25	30	33	48	60	58	80	110
L3	46	61	72	75	82	88	115	132	140	175	220	240
L4	23	35	44	45	49	52	70	84	92	113	145	145
L6	6	7	8	9	11	12	15	18	20	25	30	40
G	G1/8"	G1/8"	G1/4"	G1/4"	G3/8"	G1/2"	G1/2"	G1/2"	G1/2"	G3/4"	G1"	G1"
α	1x30°	1,5x30°	1,5x30°	2x30°	2x30°	2,5x30°	3x30°	3x30°	3x30°	4x30°	5x30°	6x30°

Design subject to change

Revision B * 15.11.1996 *K.E.

Standard Cylinder Series SZ 250



Configuration 111

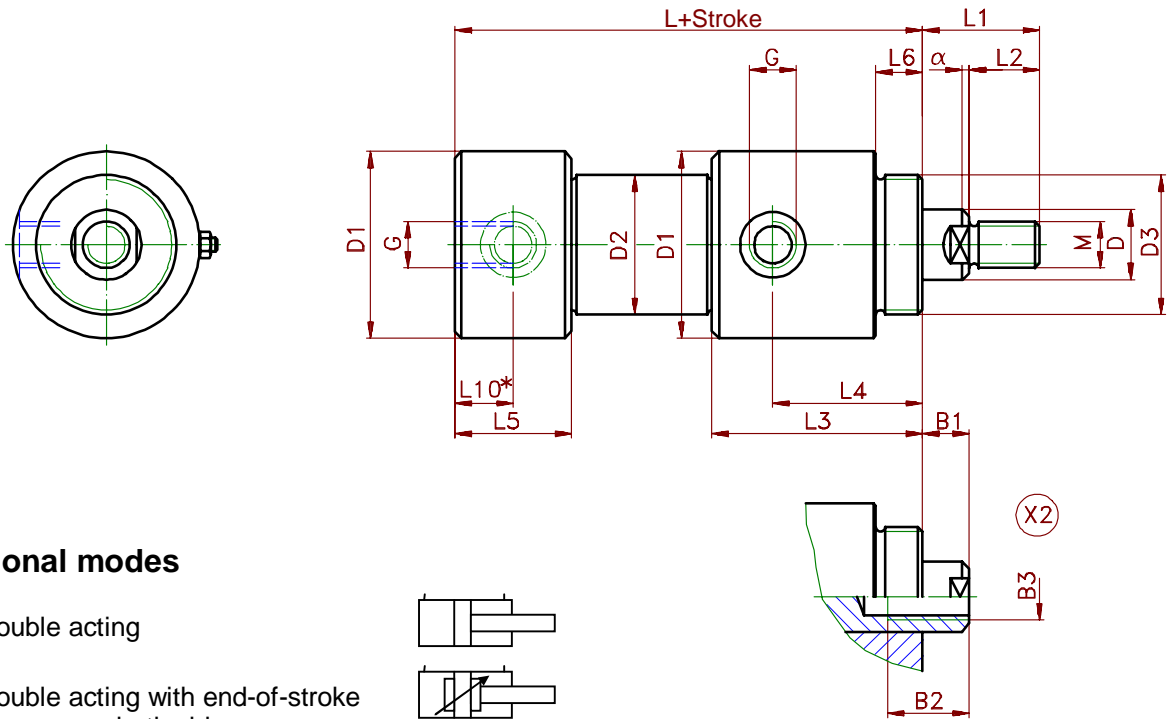

Functional modes

003 = double acting

004 = double acting with end-of-stroke damper on both sides

005 = double acting with end-of-stroke damper on rod side

006 = double acting with end-of-stroke damper on bottom side

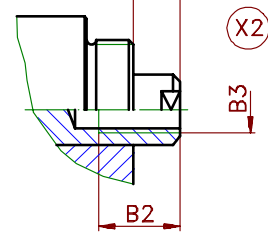
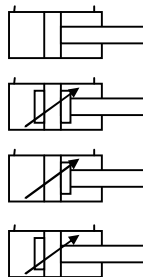

Piston rod end with female thread
Indicate required size when ordering
Or according to customers drawing

L10* only if radial port at bottom requested (indicate with cylinder order) !

Piston-ø	16	20	25	32	40	50	63	80	100	125	160	200
D rod ø	10	12	16	20	25	32	40	50	60	80	100	125
M	M8	M10	M14	M16	M20x1,5	M24x2	M30x2	M35x1,5	M45x1,5	M58x1,5	M80x2	M110x2
D1	32	37	45	50	64	75	95	115	140	180	225	280
D2	22	25	30	38	48	60	75	92	115	145	190	245
D3	M22x1,5	M32x1,5	M38x1,5	M42x1,5	M52x2	M60x2	M76x2	M92x2	M110x3	M155x3	M180x3	M200x3
L 003	64	84	100	110	118	132	157	172	184	232	300	340
L 004	84	114	140	150	158	182	207	232	254	312	400	460
L 005/006	74	99	120	130	138	157	182	202	219	272	350	400
L1	20	25	31	37	43	50	53	73	85	88	110	150
L2	12	15	20	22	25	30	33	48	60	58	80	110
L3	46	61	72	75	82	88	115	132	140	175	220	240
L4	23	35	44	45	49	52	70	84	92	113	145	145
L5	30	38	39	46	47	52	62	67	67	85	100	120
L6	8	9	11	14	16	20	25	35	35	48	68	87
L10*	8	11	11	13	13	15	16	18	18	20	25	25
G	G1/8"	G1/8"	G1/4"	G1/4"	G3/8"	G1/2"	G1/2"	G1/2"	G1/2"	G3/4"	G1"	G1"
α	1x30°	1,5x30°	1,5x30°	2x30°	2x30°	2,5x30°	3x30°	3x30°	3x30°	4x30°	5x30°	6x30°

Design subject to change

Revision B * 15.11.1996 *K.E.

Standard Cylinder Series SZ 250

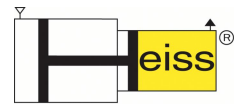

Configuration 111-1

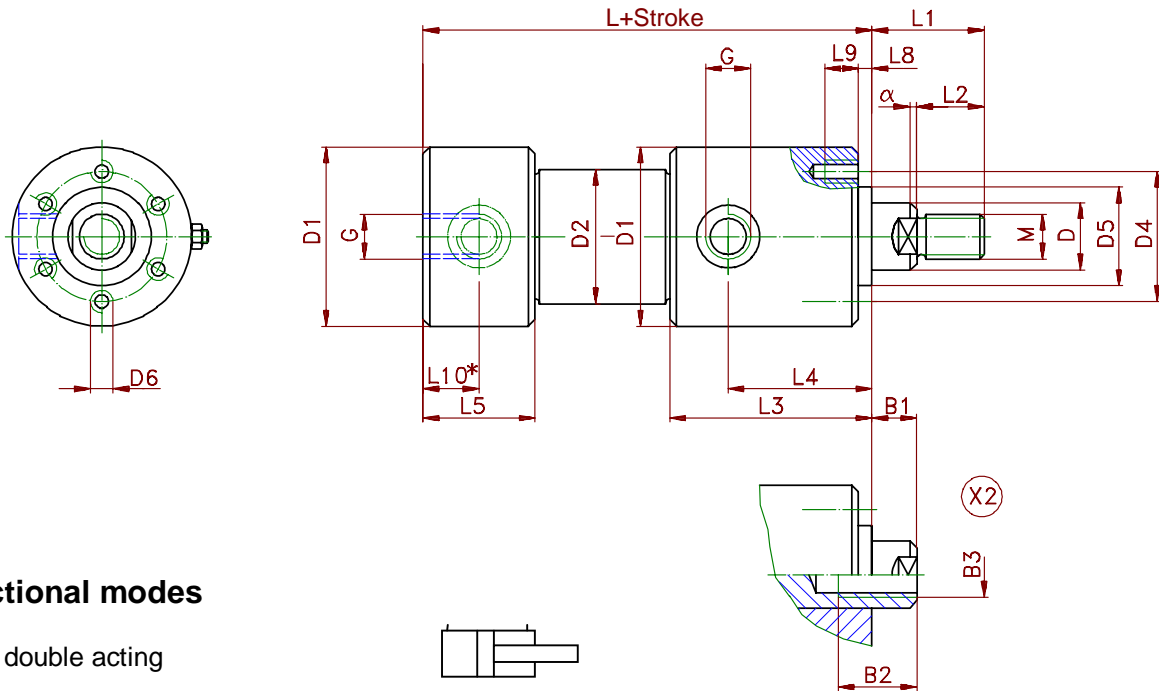

Functional modes

003 = double acting

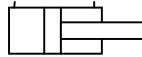

004 = double acting with end-of-stroke damper on both sides

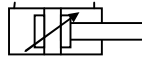

005 = double acting with end-of-stroke damper on rod side

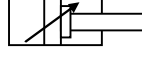

006 = double acting with end-of-stroke damper on bottom side

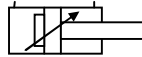

Piston rod end with female thread
Indicate required size when ordering
Or according to customers drawing

L10* only if radial port at bottom requested (indicate with cylinder order) !

Piston-ø	16	20	25	32	40	50	63	80	100	125	160	200
D rod ø	10	12	16	20	25	32	40	50	60	80	100	125
M	M8	M10	M14	M16	M20x1,5	M24x2	M30x2	M35x1,5	M45x1,5	M58x1,5	M80x2	M110x2
D1	32	37	45	50	64	75	95	115	140	180	225	280
D2	22	25	30	38	48	60	75	92	115	145	190	245
D4	26	30	36	42	54	64	75	95	110	140	180	220
D5 f7	20	22	26	32	38	44	55	65	80	100	130	160
D6	M4	M5	M6	M6	M6	M8	M10	M12	M16	M20	M27	M36
L 003	64	84	100	110	118	132	157	172	184	232	300	340
L 004	84	114	140	150	158	182	207	232	254	312	400	460
L 005/006	74	99	120	130	138	157	182	202	219	272	350	400
L1	20	25	31	37	43	50	53	73	85	88	110	150
L2	12	15	20	22	25	30	33	48	60	58	80	110
L3	46	61	72	75	82	88	115	132	140	175	220	240
L4	23	35	44	45	49	52	70	84	92	113	145	145
L5	30	38	39	46	47	52	62	67	67	85	100	120
L8	2	2	2	3	3	3	3	3	3	5	5	5
L9	8	10	12	12	15	15	20	25	30	35	45	55
L10*	8	11	11	13	13	15	16	18	18	20	25	25
G	G1/8"	G1/8"	G1/4"	G1/4"	G3/8"	G1/2"	G1/2"	G1/2"	G1/2"	G3/4"	G1"	G1"
α	1x30°	1,5x30°	1,5x30°	2x30°	2x30°	2,5x30°	3x30°	3x30°	3x30°	4x30°	5x30°	6x30°

Design subject to change

Revision B * 15.11.1996 *K.E.

Standard Cylinder Series SZ 250



Configuration 111-2

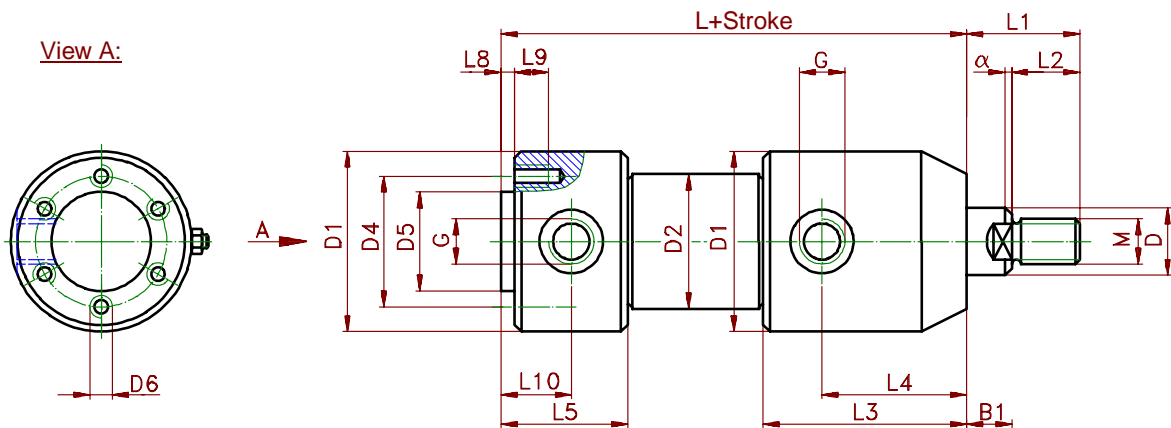

Functional modes

003 = double acting

004 = double acting with end-of-stroke damper on both sides

005 = double acting with end-of-stroke damper on rod side

006 = double acting with end-of-stroke damper on bottom side

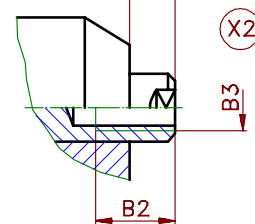
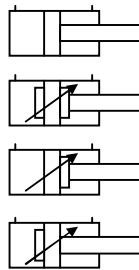

Piston rod end with female thread
Indicate required size when ordering
Or according to customers drawing.

Piston-ø	16	20	25	32	40	50	63	80	100	125	160	200
D rod ø	10	12	16	20	25	32	40	50	60	80	100	125
M	M8	M10	M14	M16	M20x1,5	M24x2	M30x2	M35x1,5	M45x1,5	M58x1,5	M80x2	M110x2
D1	32	37	45	50	64	75	95	115	140	180	225	280
D2	22	25	30	38	48	60	75	92	115	145	190	245
D4	26	30	36	42	54	64	75	95	110	140	180	220
D5 f7	20	22	26	32	38	44	55	65	80	100	130	160
D6	M4	M5	M6	M6	M6	M8	M10	M12	M16	M20	M27	M36
L 003	78	95	110	122	118	132	157	172	184	232	300	340
L 004	98	125	150	162	158	182	207	232	254	312	400	460
L 005/006	88	110	130	142	138	157	182	202	219	272	350	400
L1	20	25	31	37	43	50	53	73	85	88	110	150
L2	12	15	20	22	25	30	33	48	60	58	80	110
L3	46	61	72	75	82	88	115	132	140	175	220	240
L4	23	35	44	45	49	52	70	84	92	113	145	145
L5	44	49	49	58	47	52	62	67	67	85	100	120
L8	2	2	2	3	3	3	3	3	3	5	5	5
L9	6	8	10	10	10	13	15	16	18	25	35	40
L10	18	22	23	25	16	18	19	21	20	24	29	33
G	G1/8"	G1/8"	G1/4"	G1/4"	G3/8"	G1/2"	G1/2"	G1/2"	G1/2"	G3/4"	G1"	G1"
α	1x30°	1,5x30°	1,5x30°	2x30°	2x30°	2,5x30°	3x30°	3x30°	3x30°	4x30°	5x30°	6x30°

Design subject to change

Revision B * 15.11.1996 *K.E.

Standard Cylinder Series SZ 250



Configuration 112

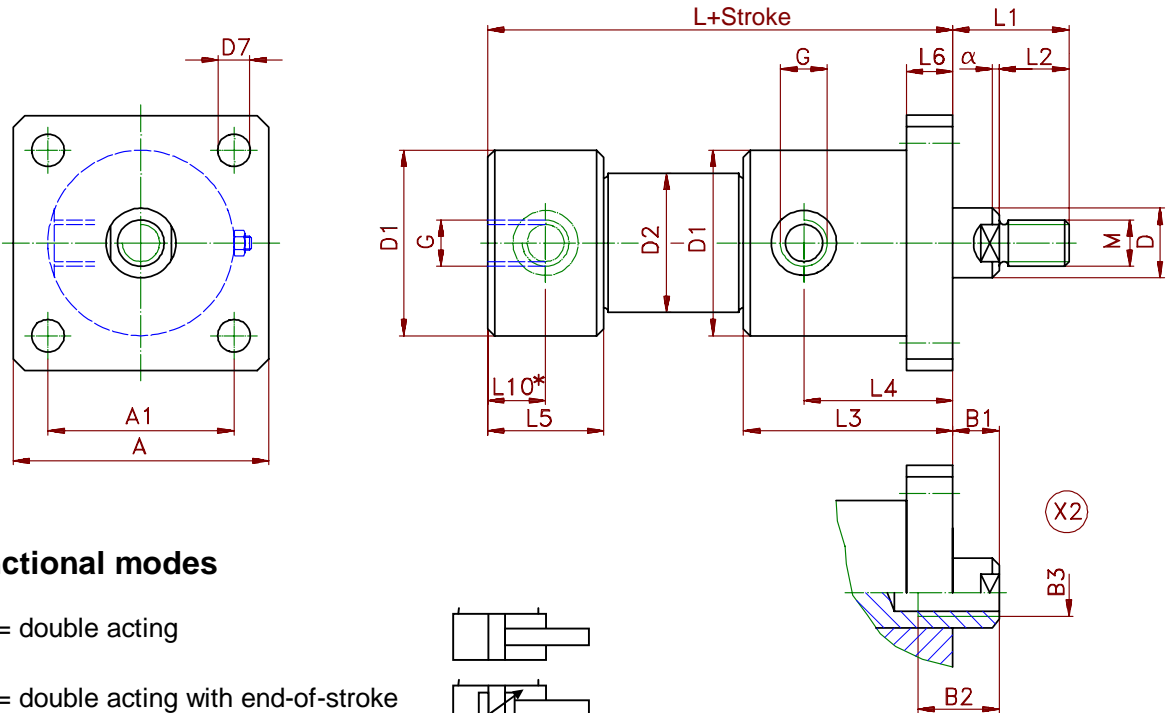

Functional modes

003 = double acting



004 = double acting with end-of-stroke damper on both sides

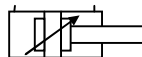

005 = double acting with end-of-stroke damper on rod side

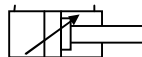

006 = double acting with end-of-stroke damper on bottom side



Piston rod end with female thread
Indicate required size when ordering
Or according to customers drawing

L10* only if radial port at bottom requested (indicate with cylinder order) !

Piston-ø	16	20	25	32	40	50	63	80	100	125	160	200
D rod ø	10	12	16	20	25	32	40	50	60	80	100	125
M	M8	M10	M14	M16	M20x1,5	M24x2	M30x2	M35x1,5	M45x1,5	M58x1,5	M80x2	M110x2
D1	32	37	45	50	64	75	95	115	140	180	225	280
D2	22	25	30	38	48	60	75	92	115	145	190	245
D7	6,5	6,5	9	11	13,5	13,5	17,5	17,5	17,5	30	39	45
L 003	64	84	100	110	118	132	157	172	184	232	300	340
L 004	84	114	140	150	158	182	207	232	254	312	400	460
L 005/006	74	99	120	130	138	157	182	202	219	272	350	400
L1	20	25	31	37	43	50	53	73	85	88	110	150
L2	12	15	20	22	25	30	33	48	60	58	80	110
L3	46	61	72	75	82	88	115	132	140	175	220	240
L4	23	35	44	45	49	52	70	84	92	113	145	145
L5	30	38	39	46	47	52	62	67	67	85	100	120
L6	8	9	11	14	16	20	25	35	35	48	68	87
L10*	8	11	11	13	13	15	16	18	18	20	25	25
A1	32	36	48	62	70	80	96	115	125	170	210	260
A	45	50	65	90	100	110	130	150	160	230	280	360
G	G1/8"	G1/8"	G1/4"	G1/4"	G3/8"	G1/2"	G1/2"	G1/2"	G1/2"	G3/4"	G1"	G1"
α	1x30°	1,5x30°	1,5x30°	2x30°	2x30°	2,5x30°	3x30°	3x30°	3x30°	4x30°	5x30°	6x30°

Design subject to change

Revision B * 15.11.1996 *K.E.

Standardzylinderbaureihe SZ 250

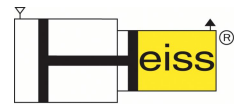

Bauform 112-1

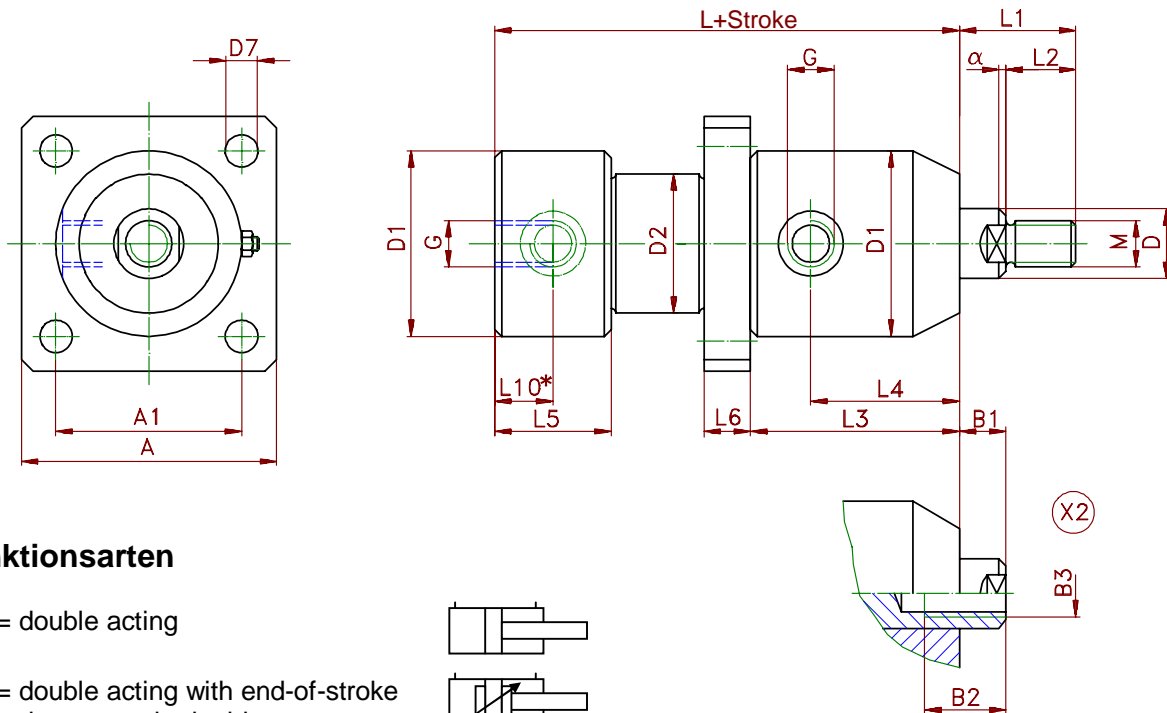

Funktionsarten

003 = double acting

004 = double acting with end-of-stroke damper on both sides

005 = double acting with end-of-stroke damper on rod side

006 = double acting with end-of-stroke damper on bottom side

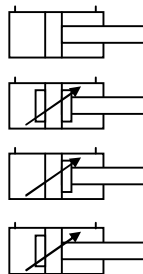

Piston rod end with female thread
Indicate required size when ordering
Or according to customers drawing

L10* only if radial port at bottom requested (indicate with cylinder order) !

Kolben-ø	16	20	25	32	40	50	63	80	100	125	160	200
D rod ø	10	12	16	20	25	32	40	50	60	80	100	125
M	M8	M10	M14	M16	M20x1,5	M24x2	M30x2	M35x1,5	M45x1,5	M58x1,5	M80x2	M110x2
D1	32	37	45	50	64	75	95	115	140	180	225	280
D2	22	25	30	38	48	60	75	92	115	145	190	245
D7	6,5	6,5	9	11	13,5	13,5	17,5	17,5	17,5	30	39	45
L 003	64	84	100	110	118	132	157	172	184	232	300	340
L 004	84	114	140	150	158	182	207	232	254	312	400	460
L 005/006	74	99	120	130	138	157	182	202	219	272	350	400
L1	20	25	31	37	43	50	53	73	85	88	110	150
L2	12	15	20	22	25	30	33	48	60	58	80	110
L3	46	61	72	75	82	88	115	132	140	175	220	240
L4	23	35	44	45	49	52	70	84	92	113	145	145
L5	30	38	39	46	47	52	62	67	67	85	100	120
L6	8	9	11	14	16	20	25	35	35	48	68	87
L10*	8	11	11	13	13	15	16	18	18	20	25	25
A1	32	36	48	62	70	80	96	115	125	170	210	260
A	45	50	65	90	100	110	130	150	160	230	280	360
G	G1/8"	G1/8"	G1/4"	G1/4"	G3/8"	G1/2"	G1/2"	G1/2"	G1/2"	G3/4"	G1"	G1"
α	1x30°	1,5x30°	1,5x30°	2x30°	2x30°	2,5x30°	3x30°	3x30°	3x30°	4x30°	5x30°	6x30°

Design subject to change

Revision B * 15.11.1996 *K.E.

Standard Cylinder Series SZ 250



Configuration 113

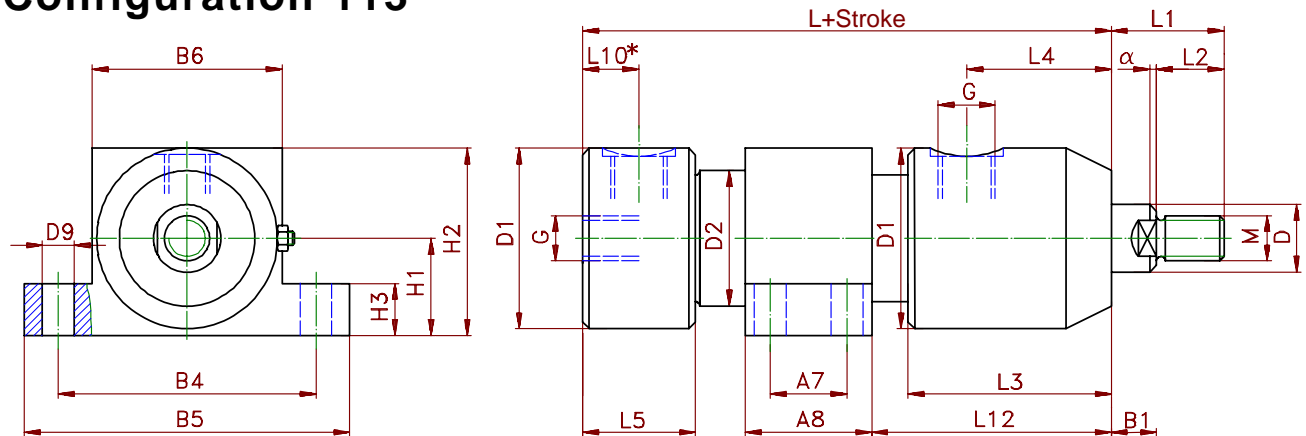

Functional modes

003 = double acting

004 = double acting with end-of-stroke damper on both sides

005 = double acting with end-of-stroke damper on rod side

006 = double acting with end-of-stroke damper on bottom side

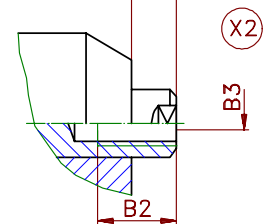
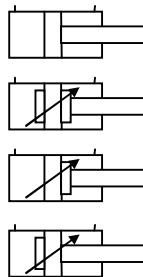

Piston rod end with female thread
Indicate required size when ordering
Or according to customers drawing

L10* only if radial port at bottom requested (indicate with cylinder order) !

Piston - \varnothing	16	20	25	32	40	50	63	80	100	125	160	200			
D Kst \varnothing	10	12	16	20	25	32	40	50	60	80	100	125			
M	M8	M10	M14	M16	M20x1,5	M24x2	M30x2	M35x1,5	M45x1,5	M58x1,5	M80x2	M110x2			
D1	32	37	45	50	64	75	95	115	140	180	225	2800			
D2	22	25	30	38	48	60	75	92	115	145	190	2455			
D9	7	9	11	13,5	17,5	17,5	21,5	21,5	26						
L 003	64	84	100	110	118	132	157	172	184	232	300	3400			
L 004	84	114	140	150	158	182	207	232	254	312	400	460			
L 005/006	74	99	120	130	138	157	182	202	219	272	350	400			
L1	20	25	31	37	43	50	53	73	85	88	110	150			
L2	12	15	20	22	25	30	33	48	60	58	80	110			
L3	46	61	72	75	82	88	115	132	140	175	220	240			
L4	23	35	44	45	49	52	70	84	92	113	145	145			
L5	30	38	39	46	47	52	62	67	67	85	100	120			
L10*	8	11	11	13	13	15	16	18	18						
L12	- variable - please indicate desired dimension when ordering														
A7	22	24	28	30	38	46	60	80	100	For piston sizes 125, 160 and 200 please request catalogue sheet K - 250 - 083					
A8	35	40	50	55	70	80	100	120	150						
B4	45	55	70	80	100	110	135	155	190						
B5	60	75	90	110	130	140	175	195	240						
B6	32	37	45	50	64	75	95	115	140						
H1	18	21	26	28	36	41	50	60	75						
H2	35	40	50	55	70	80	100	120	150						
H3	10	15	18	20	25	30	40	45	50						
G	G1/8"	G1/8"	G1/4"	G1/4"	G3/8"	G1/2"	G1/2"	G1/2"	G1/2"				G3/4"	G1"	G1"
α	1x30°	1,5x30°	1,5x30°	2x30°	2x30°	2,5x30°	3x30°	3x30°	3x30°				4x30°	5x30°	6x30°

Design subject to change

Revision B * 15.11.1996 *K.E.

Standard Cylinder Series SZ 160

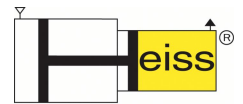

Configuration 113-1

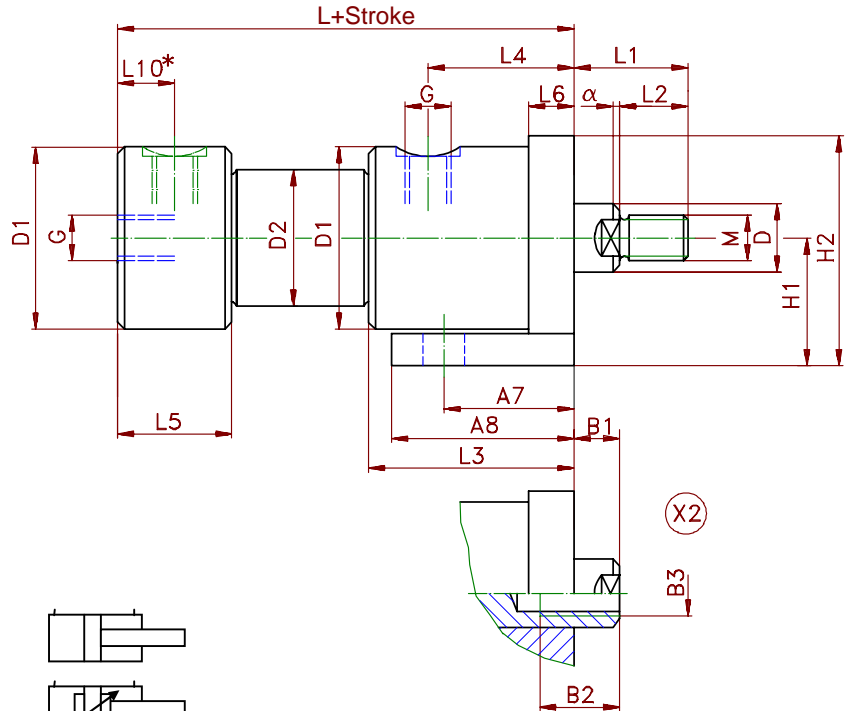
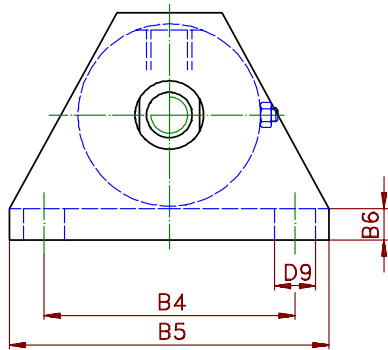

Functional modes

003 = double acting

004 = double acting with end-of-stroke damper on both sides

005 = double acting with end-of-stroke damper on rod side

006 = double acting with end-of-stroke damper on bottom side

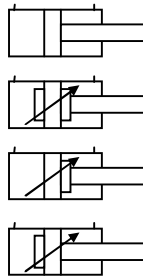

Piston rod end with female thread
Indicate desired size when ordering
Or according to customers drawing

L10* only if radial port at bottom requested (indicate with cylinder order) !

Piston-ø	16	20	25	32	40	50	63	80	100	125	160	200
D rod ø	10	12	16	20	25	32	40	50	60	80	100	125
M	M8	M10	M14	M16	M20x1,5	M24x2	M30x2	M35x1,5	M45x1,5	M58x1,5	M80x2	M110x2
D1	32	37	45	50	64	75	95	115	140	180	225	280
D2	22	25	30	38	48	60	75	92	115	145	190	245
D9	7	9	11	13,5	17,5	17,5	21,5	21,5	26			
L 003	64	84	100	110	118	132	157	172	184	232	300	340
L 004	84	114	140	150	158	182	207	232	254	312	400	460
L 005/006	74	99	120	130	138	157	182	202	219	272	350	400
L1	20	25	31	37	43	50	53	73	85	88	110	150
L2	12	15	20	22	25	30	33	48	60	58	80	110
L3	46	61	72	75	82	88	115	132	140	175	220	240
L4	23	35	44	45	49	52	70	84	92	113	145	145
L5	30	38	39	46	47	52	62	67	67	85	100	120
L6	8	9	11	14	16	20	25	35	35	For piston sizes 125, 160 and 200 please request catalogue sheet K - 250 - 083		
L10*	8	11	11	13	13	15	16	18	18			
A7	20	22	24	30	35	45	50	65	70			
A8	40	45	55	50	65	80	90	105	140			
B4	40	45	60	80	90	110	130	165	200			
B5	55	62	80	110	130	140	170	215	260			
B6	6	8	10	12	15	20	25	30	40			
H1	22	25	32	40	50	65	80	100	115			
H2	40	45	55	70	90	110	135	170	190			
G	G1/8"	G1/8"	G1/4"	G1/4"	G3/8"	G1/2"	G1/2"	G1/2"	G1/2"	G3/4"	G1"	G1"
α	1x30°	1,5x30°	1,5x30°	2x30°	2x30°	2,5x30°	3x30°	3x30°	3x30°	4x30°	5x30°	6x30°

Design subject to change

Revision B * 15.11.1996 *K.E.*

Standard Cylinder Series SZ 250

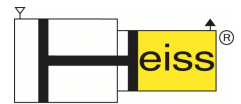

Configuration 113-2

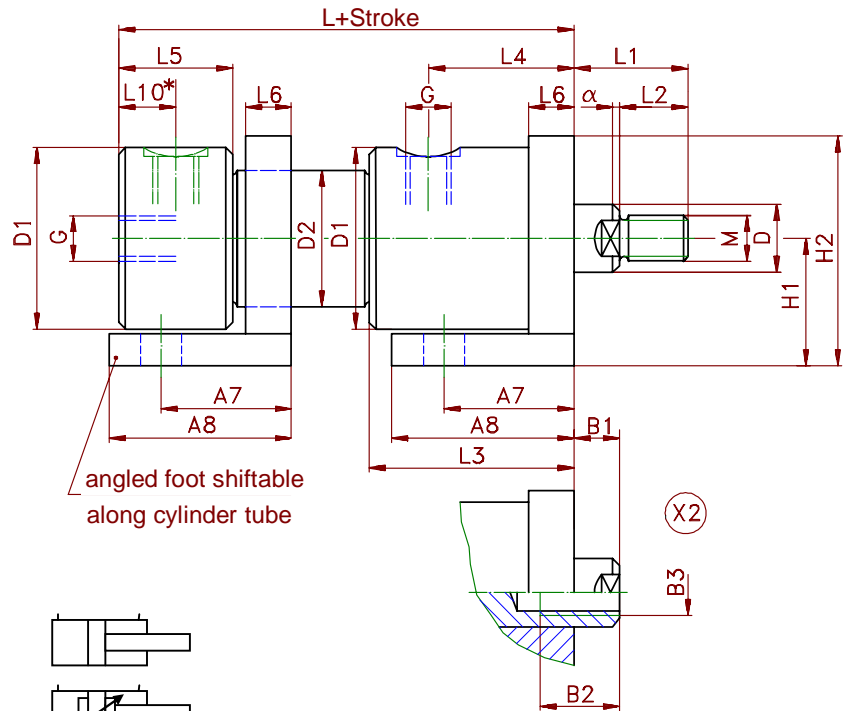
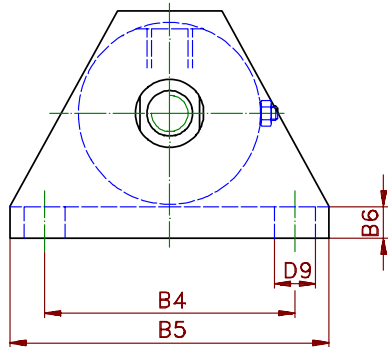

Functional modes

003 = double acting

004 = double acting with end-of-stroke damper on both sides

005 = double acting with end-of-stroke damper on rod side

006 = double acting with end-of-stroke damper on rod side

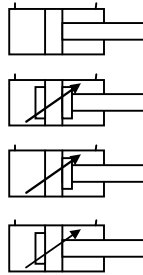

Piston rod end with female thread
Indicate desired sizes when ordering
Or according to customers drawing

L10* only if radial port at bottom requested (indicate with cylinder order)

Piston-ø	16	20	25	32	40	50	63	80	100	125	160	200
D rod ø	10	12	16	20	25	32	40	50	60	80	100	125
M	M8	M10	M14	M16	M20x1,5	M24x2	M30x2	M35x1,5	M45x1,5	M58x1,5	M80x2	M110x2
D1	32	37	45	50	64	75	95	115	140	180	225	280
D2	22	25	30	38	48	60	75	92	115	145	190	245
D9	7	9	11	13,5	17,5	17,5	21,5	21,5	26			
L 003	64	84	100	110	118	132	157	172	184	232	300	340
L 004	84	114	140	150	158	182	207	232	254	312	400	460
L 005/006	74	99	120	130	138	157	182	202	219	272	350	400
L1	20	25	31	37	43	50	53	73	85	88	110	150
L2	12	15	20	22	25	30	33	48	60	58	80	110
L3	46	61	72	75	82	88	115	132	140	175	220	240
L4	23	35	44	45	49	52	70	84	92	113	145	145
L5	30	38	39	46	47	52	62	67	67	85	100	120
L6	8	9	11	14	16	20	25	35	35			
L10*	8	11	11	13	13	15	16	18	18			
A7	20	22	24	30	35	45	50	65	70			
A8	40	45	55	50	65	80	90	105	140			
B4	40	45	60	80	90	110	130	165	200			
B5	55	62	80	110	130	140	170	215	260			
B6	6	8	10	12	15	20	25	30	40			
H1	22	25	32	40	50	65	80	100	115			
H2	40	45	55	70	90	110	135	170	190			
G	G1/8"	G1/8"	G1/4"	G1/4"	G3/8"	G1/2"	G1/2"	G1/2"	G1/2"	G3/4"	G1"	G1"
α	1x30°	1,5x30°	1,5x30°	2x30°	2x30°	2,5x30°	3x30°	3x30°	3x30°	4x30°	5x30°	6x30°

For piston sizes 125, 160 and 200 please request catalogue sheet K - 250 - 083

Design subject to change

Revision B * 15.11.1996 *K.E.*

Standard Cylinder Series SZ 250

Configuration 114

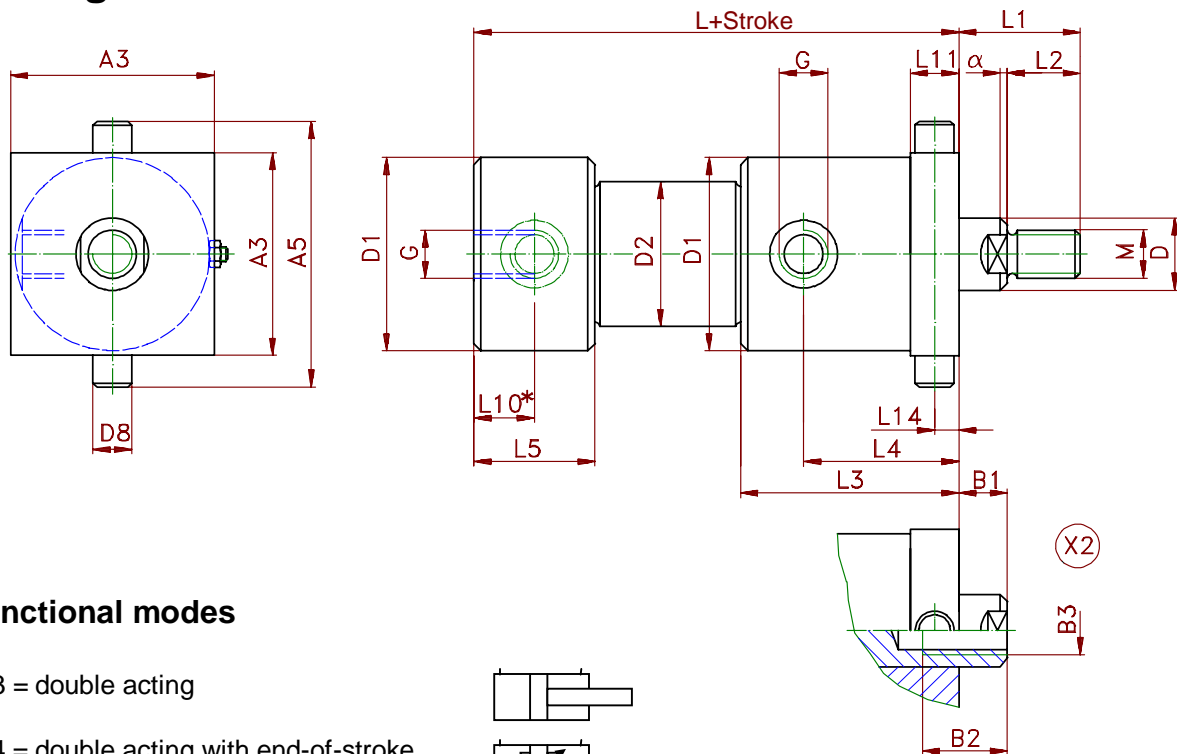

Functional modes

003 = double acting

004 = double acting with end-of-stroke damper on both sides

005 = double acting with end-of-stroke damper on rod side

006 = double acting with end-of-stroke damper on rod side

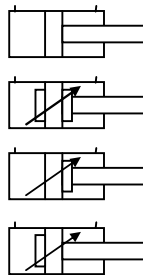

Piston rod end with female thread
Indicate desired sizes when ordering
Or according to customers drawing

L10* only if radial port at bottom requested (indicate with cylinder order)

Piston-ø	16	20	25	32	40	50	63	80	100	125	160	200
D rod ø	10	12	16	20	25	32	40	50	60	80	100	125
M	M8	M10	M14	M16	M20x1,5	M24x2	M30x2	M35x1,5	M45x1,5	M58x1,5	M80x2	M110x2
D1	32	37	45	50	64	75	95	115	140	180	225	280
D2	22	25	30	38	48	60	75	92	115	145	190	245
D8 f7	8	10	12	16	20	25	30	40	50	60	80	100
L 003	64	84	100	110	118	132	157	172	184	232	300	340
L 004	84	114	140	150	158	182	207	232	254	312	400	460
L 005/006	74	99	120	130	138	157	182	202	219	272	350	400
L1	20	25	31	37	43	50	53	73	85	88	110	150
L2	12	15	20	22	25	30	33	48	60	58	80	110
L3	46	61	72	75	82	88	115	132	140	175	220	240
L4	23	35	44	45	49	52	70	84	92	113	145	145
L5	30	38	39	46	47	52	62	67	67	85	100	120
L10*	8	11	11	13	13	15	16	18	18	20	25	25
L11	10	12	14	20	22	28	32	42	54	64	86	110
L14	5	6	7	10	11	14	16	21	27	32	43	55
A3	35	40	50	55	65	80	100	120	145	185	230	285
A5	50	60	70	80	105	130	160	200	240	300	390	480
G	G1/8"	G1/8"	G1/4"	G1/4"	G3/8"	G1/2"	G1/2"	G1/2"	G1/2"	G3/4"	G1"	G1"
α	1x30°	1,5x30°	1,5x30°	2x30°	2x30°	2,5x30°	3x30°	3x30°	3x30°	4x30°	5x30°	6x30°

Design subject to change

Revision B * 15.11.1996 *K.E.

Standard Cylinder Series SZ 250



Configuration 114-1

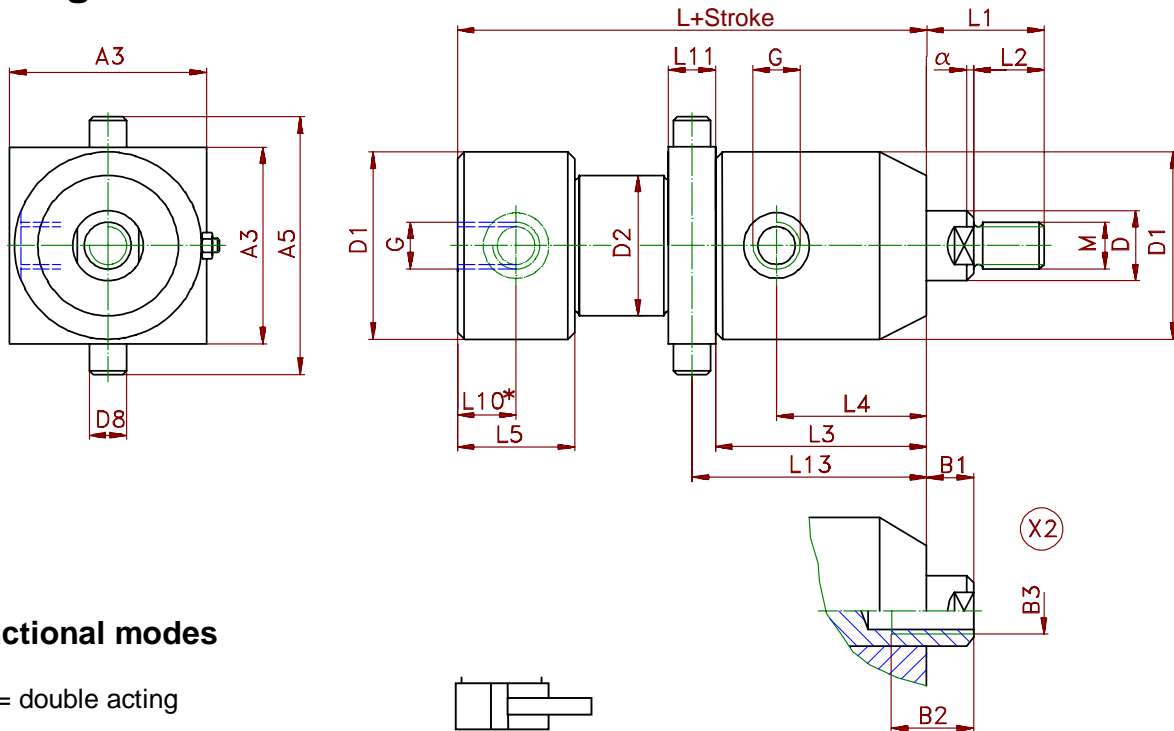

Functional modes

003 = double acting

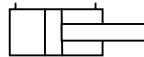

004 = double acting with end-of-stroke damper on both sides

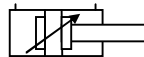

005 = double acting with end-of-stroke damper on rod side

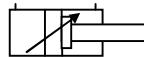

006 = double acting with end-of-stroke damper on bottom side

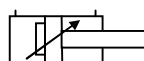

Piston rod end with female thread
Indicate required size when ordering
Or according to customers drawing

L10* only if radial port at bottom requested (indicate with cylinder order) !

Piston-ø	16	20	25	32	40	50	63	80	100	125	160	200
D rod ø	10	12	16	20	25	32	40	50	60	80	100	125
M	M8	M10	M14	M16	M20x1,5	M24x2	M30x2	M35x1,5	M45x1,5	M58x1,5	M80x2	M110x2
D1	32	37	45	50	64	75	95	115	140	180	225	280
D2	22	25	30	38	48	60	75	92	115	145	190	245
D8 f7	8	10	12	16	20	25	30	40	50	60	80	100
L 003	64	84	100	110	118	132	157	172	184	232	300	340
L 004	84	114	140	150	158	182	207	232	254	312	400	460
L 005/006	74	99	120	130	138	157	182	202	219	272	350	400
L1	20	25	31	37	43	50	53	73	85	88	110	150
L2	12	15	20	22	25	30	33	48	60	58	80	110
L3	46	61	72	75	82	88	115	132	140	175	220	240
L4	23	35	44	45	49	52	70	84	92	113	145	145
L5	30	38	39	46	47	52	62	67	67	85	100	120
L10*	8	11	11	13	13	15	16	18	18	20	25	25
L11	10	12	14	20	22	28	32	42	54	64	86	110
L13	51	67	79	85	93	102	131	153	167	207	263	295
A3	35	40	50	55	65	80	100	120	145	185	230	285
A5	50	60	70	80	105	130	160	200	240	300	390	480
G	G1/8"	G1/8"	G1/4"	G1/4"	G3/8"	G1/2"	G1/2"	G1/2"	G1/2"	G3/4"	G1"	G1"
α	1x30°	1,5x30°	1,5x30°	2x30°	2x30°	2,5x30°	3x30°	3x30°	3x30°	4x30°	5x30°	6x30°

Design subject to change

Revision B * 15.11.1996 *K.E.

Standard Cylinder Series SZ 250



Configuration 115

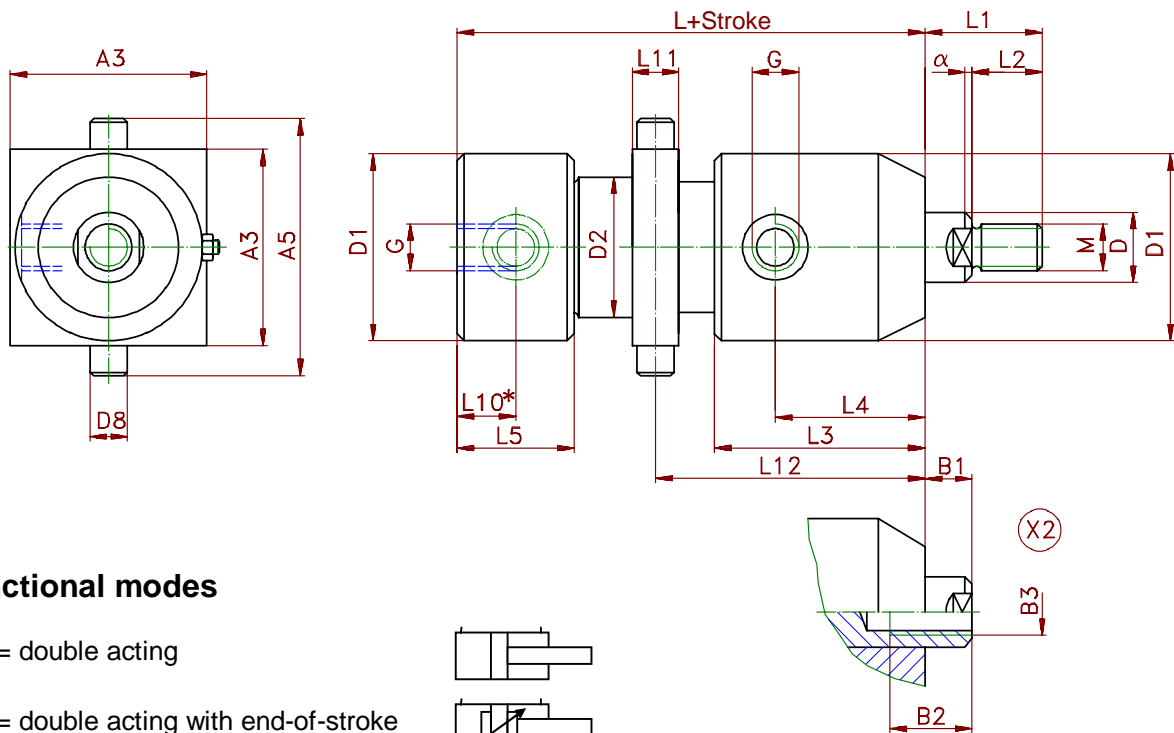

Functional modes

003 = double acting

004 = double acting with end-of-stroke damper on both sides

005 = double acting with end-of-stroke damper on rod side

006 = double acting with end-of-stroke damper on bottom side

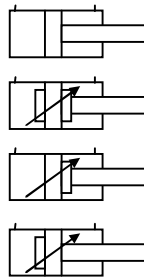

Piston rod end with female thread
Indicate desired size when ordering
Or according to customers drawing

L10* only if radial port at bottom requested (indicate with cylinder order) !

Piston-ø	16	20	25	32	40	50	63	80	100	125	160	200
D rod ø	10	12	16	20	25	32	40	50	60	80	100	125
M	M8	M10	M14	M16	M20x1,5	M24x2	M30x2	M35x1,5	M45x1,5	M58x1,5	M80x2	M110x2
D1	32	37	45	50	64	75	95	115	140	180	225	280
D2	22	25	30	38	48	60	75	92	115	145	190	245
D8 f7	8	10	12	16	20	25	30	40	50	60	80	100
L 003	64	84	100	110	118	132	157	172	184	232	300	340
L 004	84	114	140	150	158	182	207	232	254	312	400	460
L 005/006	74	99	120	130	138	157	182	202	219	272	350	400
L1	20	25	31	37	43	50	53	73	85	88	110	150
L2	12	15	20	22	25	30	33	48	60	58	80	110
L3	46	61	72	75	82	88	115	132	140	175	220	240
L4	23	35	44	45	49	52	70	84	92	113	145	145
L5	30	38	39	46	47	52	62	67	67	85	100	120
L10*	8	11	11	13	13	15	16	18	18	20	25	25
L11	10	12	14	20	22	28	32	42	54	64	86	110
L12	- variable - indicate desired size when ordering											
A3	35	40	50	55	65	80	100	120	145	185	230	285
A5	50	60	70	80	105	130	160	200	240	300	390	480
G	G1/8"	G1/8"	G1/4"	G1/4"	G3/8"	G1/2"	G1/2"	G1/2"	G1/2"	G3/4"	G1"	G1"
α	1x30°	1,5x30°	1,5x30°	2x30°	2x30°	2,5x30°	3x30°	3x30°	3x30°	4x30°	5x30°	6x30°

Design subject to change

Revision B * 15.11.1996 *K.E.

Standard Cylinder Series SZ 250



Configuration 116

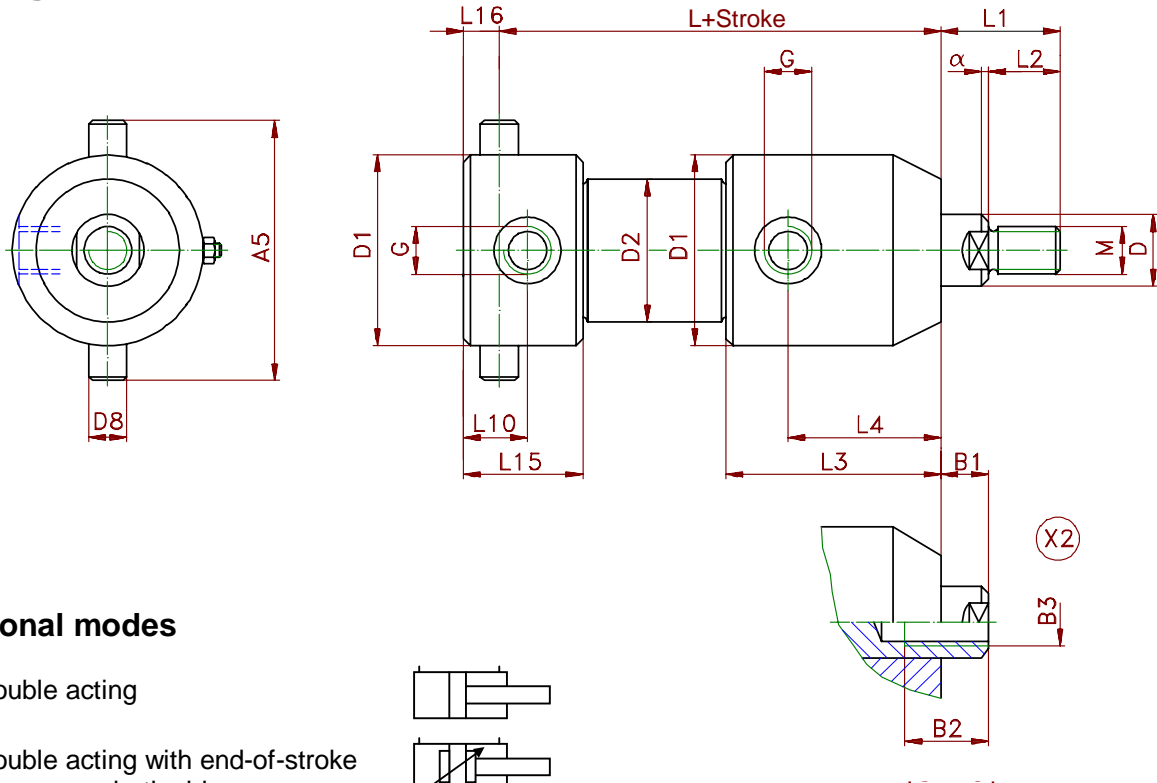

Functional modes

003 = double acting

004 = double acting with end-of-stroke damper on both sides

005 = double acting with end-of-stroke damper on rod side

006 = double acting with end-of-stroke damper on bottom side

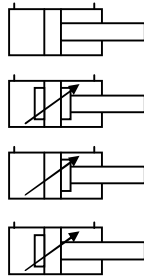

Piston rod end with female thread
Indicate required size when ordering
Or according to customers drawing

Piston-ø	16	20	25	32	40	50	63	80	100	125	160	200
D rod ø	10	12	16	20	25	32	40	50	60	80	100	125
M	M8	M10	M14	M16	M20x1,5	M24x2	M30x2	M35x1,5	M45x1,5	M58x1,5	M80x2	M110x2
D1	32	37	45	50	64	75	95	115	140	180	225	280
D2	22	25	30	38	48	60	75	92	115	145	190	245
D8 f7	8	10	12	16	20	25	30	40	50	60	80	100
L 003	71	87	100	109	122	139	165	182	192	257	335	385
L 004	91	117	140	149	162	189	215	242	262	337	435	505
L 005/006	81	102	120	129	142	164	190	212	227	297	385	445
L1	20	25	31	37	43	50	53	73	85	88	110	150
L2	12	15	20	22	25	30	33	48	60	58	80	110
L3	46	61	72	75	82	88	115	132	140	175	220	240
L4	23	35	44	45	49	52	70	84	92	113	145	145
L10	20	22	22	28	33	42	52	59	62	97	120	143
L15	44	49	49	58	67	78	95	107	110	160	195	240
L16	7	8	10	13	16	19	25	30	35	50	60	75
A5	50	60	70	80	105	130	160	200	240	300	390	480
G	G1/8"	G1/8"	G1/4"	G1/4"	G3/8"	G1/2"	G1/2"	G1/2"	G1/2"	G3/4"	G1"	G1"
α	1x30°	1,5x30°	1,5x30°	2x30°	2x30°	2,5x30°	3x30°	3x30°	3x30°	4x30°	5x30°	6x30°

Design subject to change

Revision B * 15.11.1996 *K.E.

Standard Cylinder Series SZ 250



Configuration 117

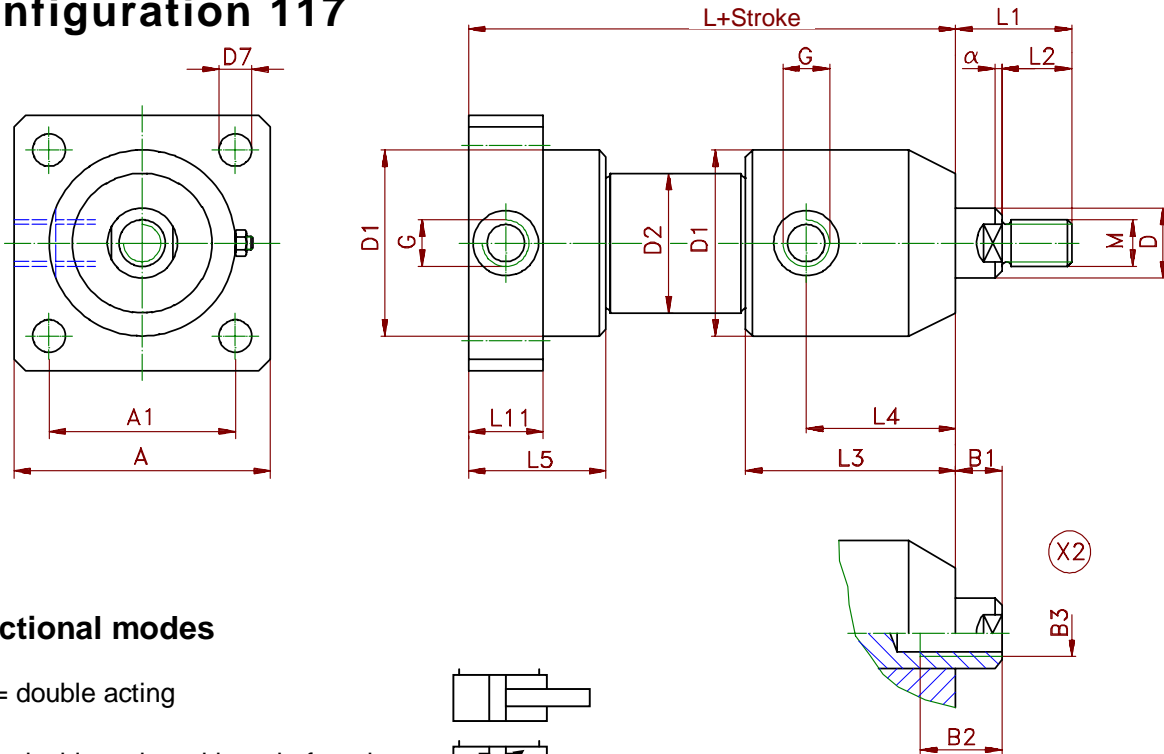

Functional modes

003 = double acting

004 = double acting with end-of-stroke damper on both sides

005 = double acting with end-of-stroke damper on rod side

006 = double acting with end-of-stroke damper on bottom side

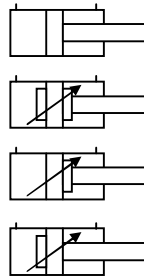

Piston rod end with female thread
Indicate required size when ordering
Or according to customers drawing

Piston-ø	16	20	25	32	40	50	63	80	100	125	160	200
D rod ø	10	12	16	20	25	32	40	50	60	80	100	125
M	M8	M10	M14	M16	M20x1,5	M24x2	M30x2	M35x1,5	M45x1,5	M58x1,5	M80x2	M110x2
D1	32	37	45	50	64	75	95	115	140	180	225	280
D2	22	25	30	38	48	60	75	92	115	145	190	245
D7	6,5	6,5	9	11	13,5	13,5	17,5	17,5	17,5	30	39	45
L 003	64	84	100	110	118	132	157	172	184	232	300	340
L 004	84	114	140	150	158	182	207	232	254	312	400	460
L 005/006	74	99	120	130	138	157	182	202	219	272	350	400
L1	20	25	31	37	43	50	53	73	85	88	110	150
L2	12	15	20	22	25	30	33	48	60	58	80	110
L3	46	61	72	75	82	88	115	132	140	175	220	240
L4	23	35	44	45	49	52	70	84	92	113	145	145
L5	30	38	39	46	47	52	62	67	67	85	100	120
L11	16	21	21	26	26	30	32	35	35	40	50	50
A1	32	36	48	62	70	80	96	115	125	170	210	260
A	45	50	65	90	100	110	130	150	160	230	280	360
G	G1/8"	G1/8"	G1/4"	G1/4"	G3/8"	G1/2"	G1/2"	G1/2"	G1/2"	G3/4"	G1"	G1"
α	1x30°	1,5x30°	1,5x30°	2x30°	2x30°	2,5x30°	3x30°	3x30°	3x30°	4x30°	5x30°	6x30°

Design subject to change

Revision B * 15.11.1996 *K.E.

Standard Cylinder Series SZ 250



Configuration 118

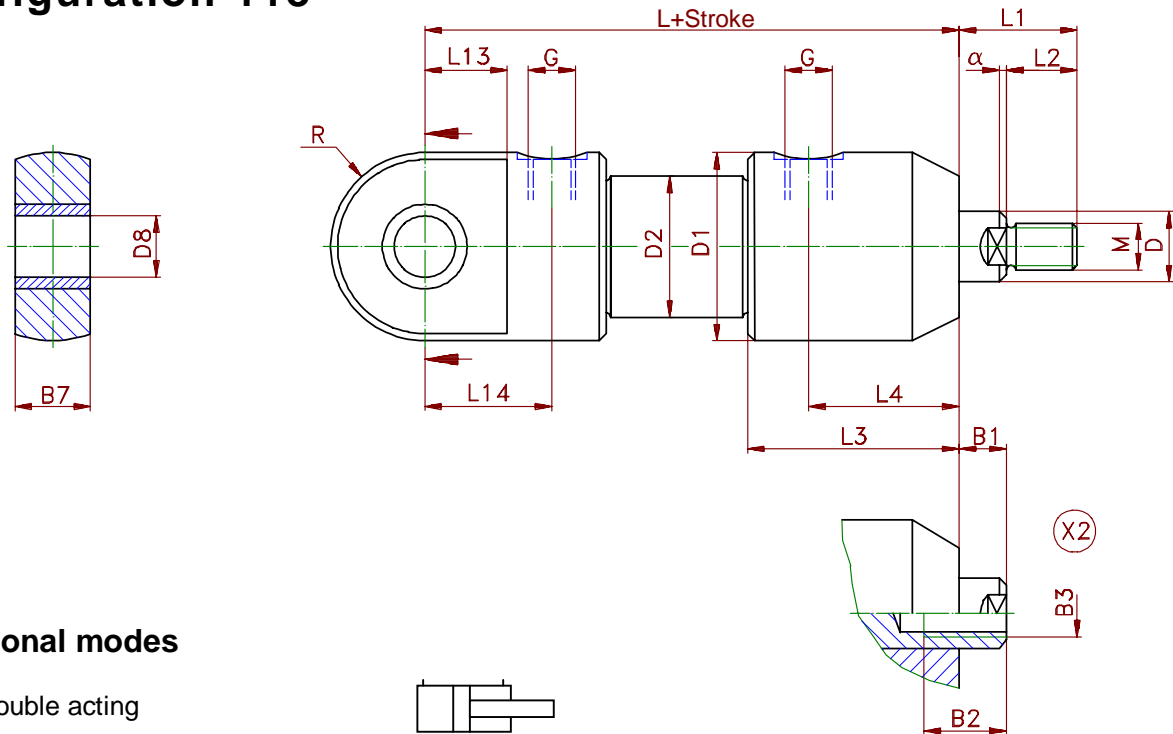

Functional modes

003 = double acting

004 = double acting with end-of-stroke damper on both sides

005 = double acting with end-of-stroke damper on rod side

006 = double acting with end-of-stroke damper on bottom side

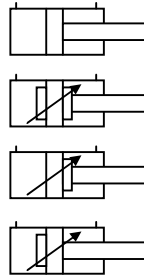

Piston rod end with female thread
Indicate required size when ordering
Or according to customers drawing

Piston-ø	16	20	25	32	40	50	63	80	100	125	160	200
D rod ø	10	12	16	20	25	32	40	50	60	80	100	125
M	M8	M10	M14	M16	M20x1,5	M24x2	M30x2	M35x1,5	M45x1,5	M58x1,5	M80x2	M110x2
D1	32	37	45	50	64	75	95	115	140	180	225	280
D2	22	25	30	38	48	60	75	92	115	145	190	245
D8 H8	8	10	12	16	20	25	30	40	50	60	80	100
L 003	82	104	122	137	154	166	207	232	254	373	470	550
L 004	102	134	162	177	194	216	257	292	324	453	570	670
L 005/006	92	119	142	157	174	191	232	262	289	413	520	610
L1	20	25	31	37	43	50	53	73	85	88	110	150
L2	12	15	20	22	25	30	33	48	60	58	80	110
L3	46	61	72	75	82	88	115	132	140	175	220	240
L4	23	35	44	45	49	52	70	84	92	113	145	145
L13	15	20	24	28	33	37	48	59	70	100	141	170
L14	24	30	35	40	49	52	67	79	90	161	195	235
B7	10	12	15	20	25	32	40	50	60	80	100	120
R	16	18,5	20	25	28	33	40	50	60	70	90	120
G	G1/8"	G1/8"	G1/4"	G1/4"	G3/8"	G1/2"	G1/2"	G1/2"	G1/2"	G3/4"	G1"	G1"
α	1x30°	1,5x30°	1,5x30°	2x30°	2x30°	2,5x30°	3x30°	3x30°	3x30°	4x30°	5x30°	6x30°

Design subject to change

Revision C * 20.01.2000 *K.E.

Standard Cylinder Series SZ 160

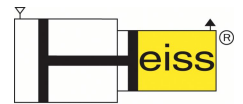

Configuration 218

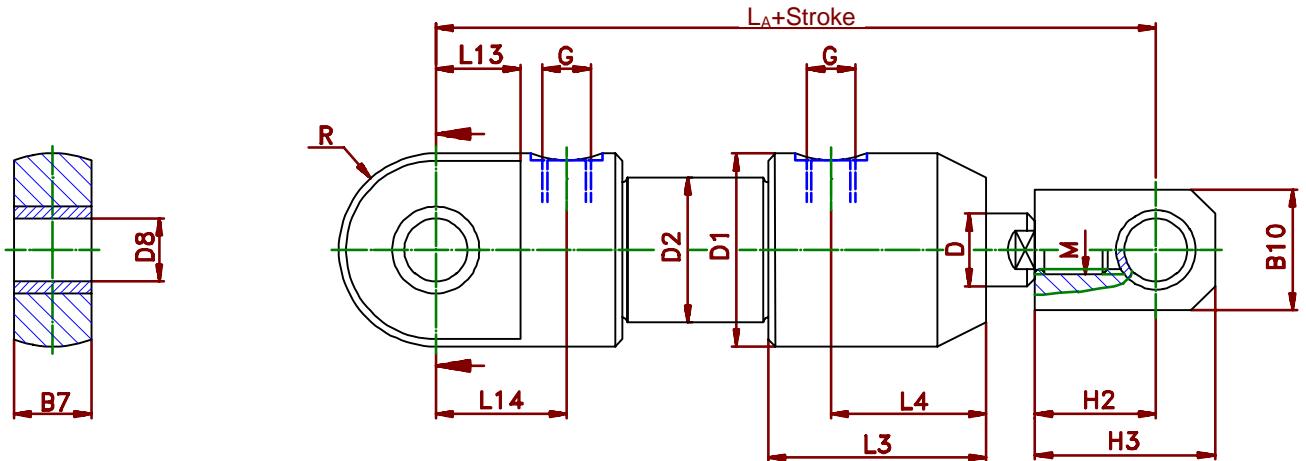

Functional modes

003 = double acting



004 = double acting with end-of-stroke damper on both sides

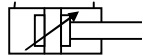

005 = double acting with end-of-stroke damper on rod side

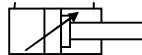

006 = double acting with end-of-stroke damper on bottom side

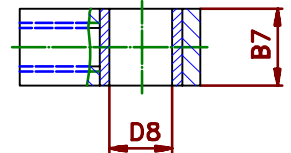
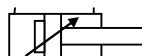

Piston-ø	16	20	25	32	40	50	63	80	100	125	160	200
D rod ø	10	12	16	20	25	32	40	50	60	80	100	125
M	M8	M10	M14	M16	M20x1,5	M24x2	M30x2	M35x1,5	M45x1,5	M58x1,5	M80x2	M110x2
D1	32	37	45	50	64	75	95	115	140	180	225	280
D2	22	25	30	38	48	60	75	92	115	145	190	245
D8 H8	8	10	12	16	20	25	30	40	50	60	80	100
LA 003	110	139	161	187	212	236	282	337	379	513	640	770
LA 004	130	169	201	227	252	286	332	397	449	593	740	890
LA 005/006	120	154	181	207	232	261	307	367	414	553	690	830
L3	46	61	72	75	82	88	115	132	140	175	220	240
L4	23	35	44	45	49	52	70	84	92	113	145	145
L13	15	20	24	28	33	37	48	59	70	100	141	170
L14	24	30	35	40	49	52	67	79	90	161	195	235
B7	10	12	15	20	25	32	40	50	60	80	100	120
B10	20	20	25	30	40	50	60	80	100	120	160	200
H2	20	25	28	35	40	50	55	80	100	110	140	180
H3	30	35	40	50	60	75	85	120	150	180	220	280
R	16	18,5	20	25	28	33	40	50	60	70	90	120
G	G1/8"	G1/8"	G1/4"	G1/4"	G3/8"	G1/2"	G1/2"	G1/2"	G1/2"	G3/4"	G1"	G1"

Design subject to change

Revision C * 20.01.2000 *K.E.

Standard Cylinder Series SZ 160



Configuration 119

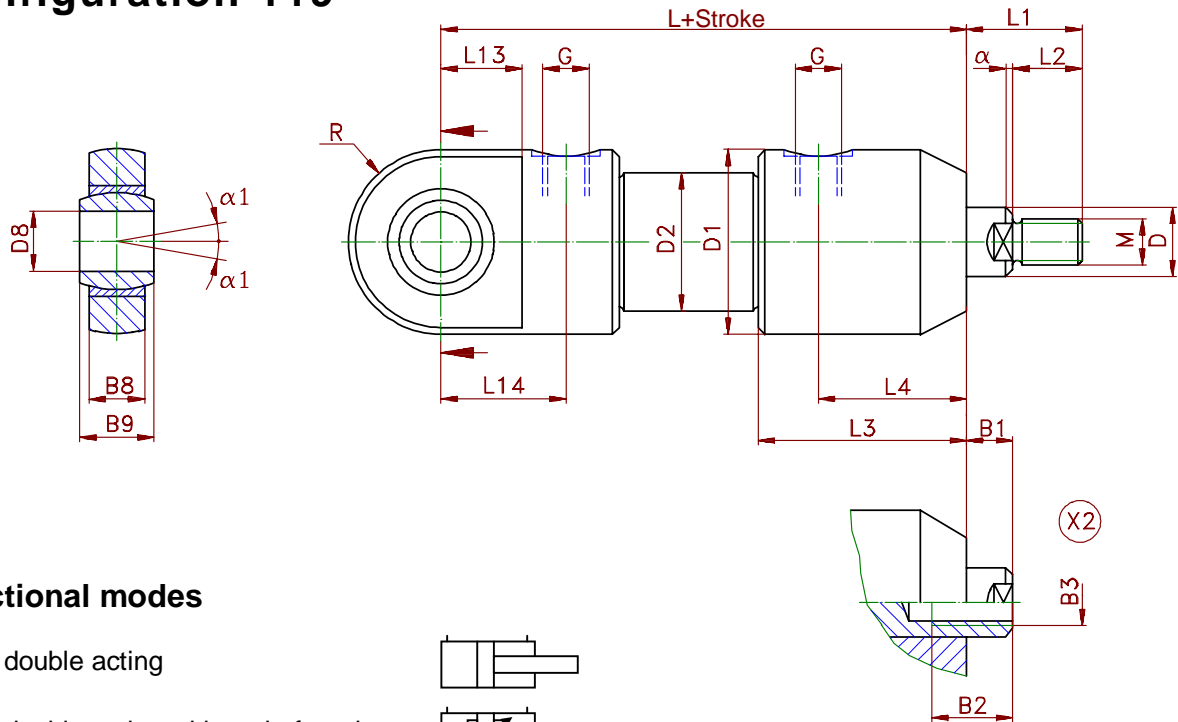

Functional modes

003 = double acting

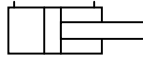

004 = double acting with end-of-stroke damper on both sides

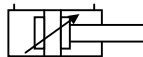

005 = double acting with end-of-stroke damper on rod side

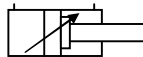

006 = double acting with end-of-stroke damper on bottom side

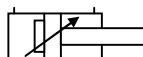

Piston rod end with female thread
Indicate desired size when ordering
Or according to customers drawing

Piston-ø	16	20	25	32	40	50	63	80	100	125	160	200
D rod ø	10	12	16	20	25	32	40	50	60	80	100	125
M	M8	M10	M14	M16	M20x1,5	M24x2	M30x2	M35x1,5	M45x1,5	M58x1,5	M80x2	M110x2
D1	32	37	45	50	64	75	95	115	140	180	225	280
D2	22	25	30	38	48	60	75	92	115	145	190	245
D8 H8	8	10	15	17	20	25	30	40	50	60	80	100
L 003	82	104	122	137	154	166	207	232	254	373	470	550
L 004	102	134	162	177	194	216	257	292	324	453	570	670
L 005/006	92	119	142	157	174	191	232	262	289	413	520	610
L1	20	25	31	37	43	50	53	73	85	88	110	150
L2	12	15	20	22	25	30	33	48	60	58	80	110
L3	46	61	72	75	82	88	115	132	140	175	220	240
L4	23	35	44	45	49	52	70	84	92	113	145	145
L13	15	20	24	28	33	37	48	59	70	100	141	170
L14	24	30	35	40	49	52	67	79	90	161	195	235
B8	5	6	9	10	12	16	18	22	28	36	45	55
B9	8	9	12	14	16	20	22	28	35	44	55	70
R	16	18,5	20	25	28	33	40	50	60	70	90	120
G	G1/8"	G1/8"	G1/4"	G1/4"	G3/8"	G1/2"	G1/2"	G1/2"	G1/2"	G3/4"	G1"	G1"
α1	15°	12°	8°	10°	9°	7°	6°	7°	6°	6°	6°	7°
α	1x30°	1,5x30°	1,5x30°	2x30°	2x30°	2,5x30°	3x30°	3x30°	3x30°	4x30°	5x30°	6x30°

Design subject to change

Revision C * 20.01.2000 *K.E.

Standard Cylinder Series SZ 250

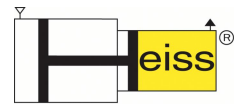

Configuration 219

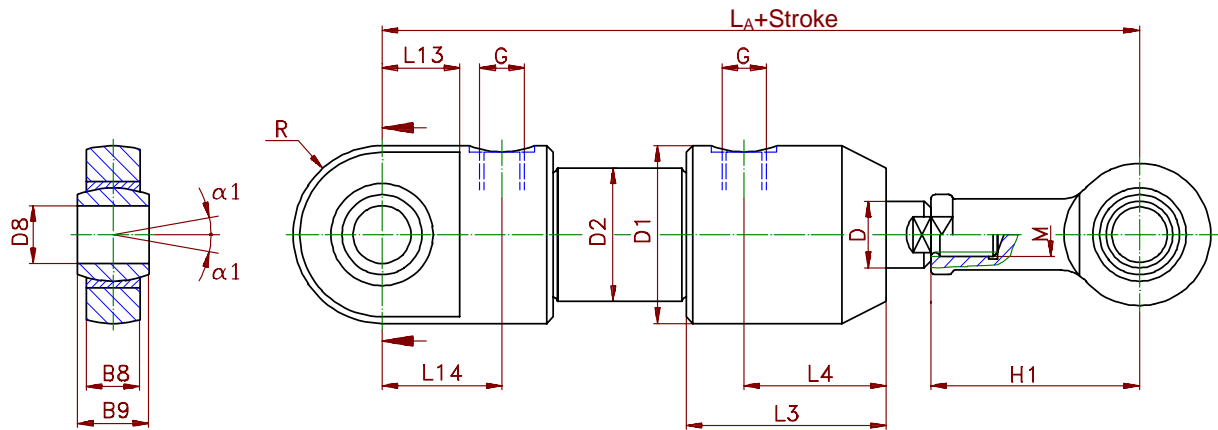

Swivel head GK
piston-ø range 16 - 63

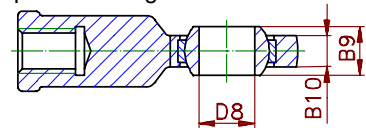

Swivel head GKA
piston-ø range 80 - 200

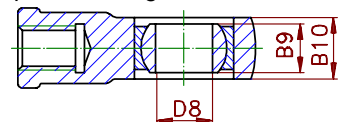

Functional modes

003 = double acting

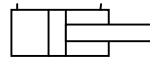

004 = double acting with end-of-stroke damper on both sides

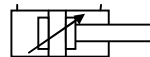

005 = double acting with end-of-stroke damper on rod side

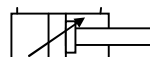

006 = double acting with end-of-stroke damper on bottom side

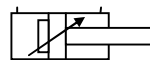

See dimension sheets for swivel heads

Piston-ø	16	20	25	32	40	50	63	80	100	125	160	200
D rod ø	10	12	16	20	25	32	40	50	60	80	100	125
M	M8	M10	M14	M16	M20x1,5	M24x2	M30x2	M35x1,5	M45x1,5	M58x1,5	M80x2	M110x2
D1	32	37	45	50	64	75	95	115	140	180	225	280
D2	22	25	30	38	48	60	75	92	115	145	190	245
D8 H8	8	10	15	17	20	25	30	40	50	60	80	100
L _A 003	126	157	194	219	249	280	337	342	384	533	670	825
L _A 004	146	187	234	259	289	330	387	402	454	613	770	945
L _A 005/006	136	172	214	239	269	305	362	372	419	573	720	885
L3	46	61	72	75	82	88	115	132	140	175	220	240
L4	23	35	44	45	49	52	70	84	92	113	145	145
L13	15	20	24	28	33	37	48	59	70	100	141	170
L14	24	30	35	40	49	52	67	79	90	161	195	235
B8	5	6	9	10	12	16	18	22	28	36	45	55
B9	8	9	12	14	16	20	22	28	35	44	55	70
B10	6	7	10	11	13	17	19	35	40	50	60	70
H1	36	43	61	67	77	94	110	85	105	130	170	235
R	16	18,5	20	25	28	33	40	50	60	70	90	120
G	G1/8"	G1/8"	G1/4"	G1/4"	G3/8"	G1/2"	G1/2"	G1/2"	G1/2"	G3/4"	G1"	G1"
α1	15°	12°	8°	10°	9°	7°	6°	7°	6°	6°	6°	7°

Design subject to change

Revision C * 20.01.2000 *K.E.

Standard Cylinder Series SZ 250



Configuration 120 - Nondifferential cylinder -

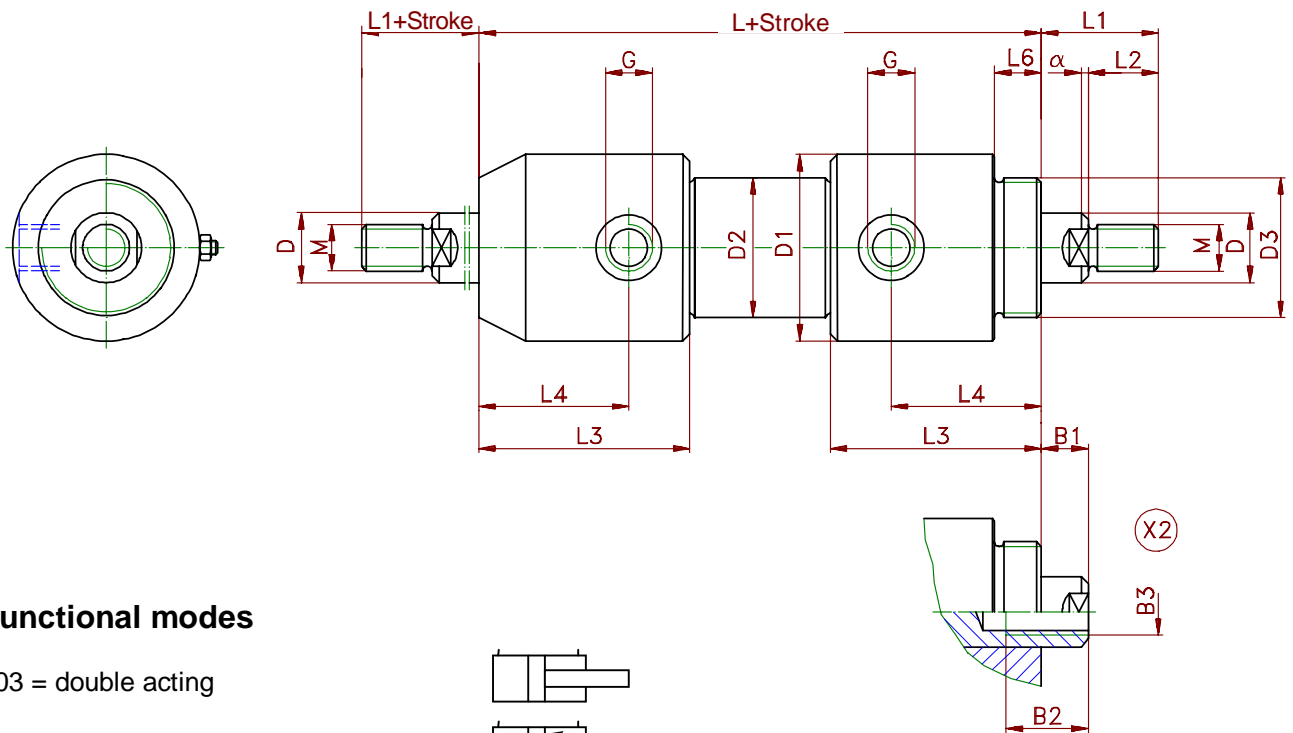

Functional modes

003 = double acting

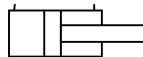

004 = double acting with end-of-stroke damper on both sides

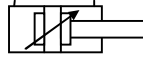

005 = double acting with end-of-stroke damper on rod side

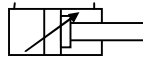

006 = double acting with end-of-stroke damper on bottom side

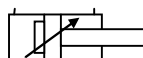

Piston rod end with female thread
Indicate desired size when ordering
Or according to customers drawing

The nondifferential cylinder can be combined with all other attachment methods!

Piston-ø	16	20	25	32	40	50	63	80	100	125	160	200
D rod ø	10	12	16	20	25	32	40	50	60	80	100	125
M	M8	M10	M14	M16	M20x1,5	M24x2	M30x2	M35x1,5	M45x1,5	M58x1,5	M80x2	M110x2
D1	32	37	45	50	64	75	95	115	140	180	225	280
D2	22	25	30	38	48	60	75	92	115	145	190	245
D3	M22x1,5	M32x1,5	M38x1,5	M42x1,5	M52x2	M60x2	M76x2	M92x2	M110x3	M155x3	M180x3	M200x3
L 003	80	107	133	139	153	168	210	237	257	322	420	460
L 004	100	137	173	179	193	218	260	297	327	402	520	580
L 005/006	90	122	153	159	173	193	235	267	292	362	470	520
L1	20	25	31	37	43	50	53	73	85	88	110	150
L2	12	15	20	22	25	30	33	48	60	58	80	110
L3	46	61	72	75	82	88	115	132	140	175	220	240
L4	23	35	44	45	49	52	70	84	92	113	145	145
L6	8	9	11	14	16	20	25	35	35	48	68	87
G	G1/8"	G1/8"	G1/4"	G1/4"	G3/8"	G1/2"	G1/2"	G1/2"	G1/2"	G3/4"	G1"	G1"
α	1x30°	1,5x30°	1,5x30°	2x30°	2x30°	2,5x30°	3x30°	3x30°	3x30°	4x30°	5x30°	6x30°

Design subject to change

Revision B * 15.11.1996 *K.E.

Standard Cylinder Series SZ 250

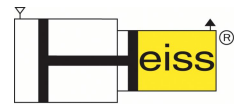

Configuration 120-1

- Nondifferential cylinder with stroke adjustment -

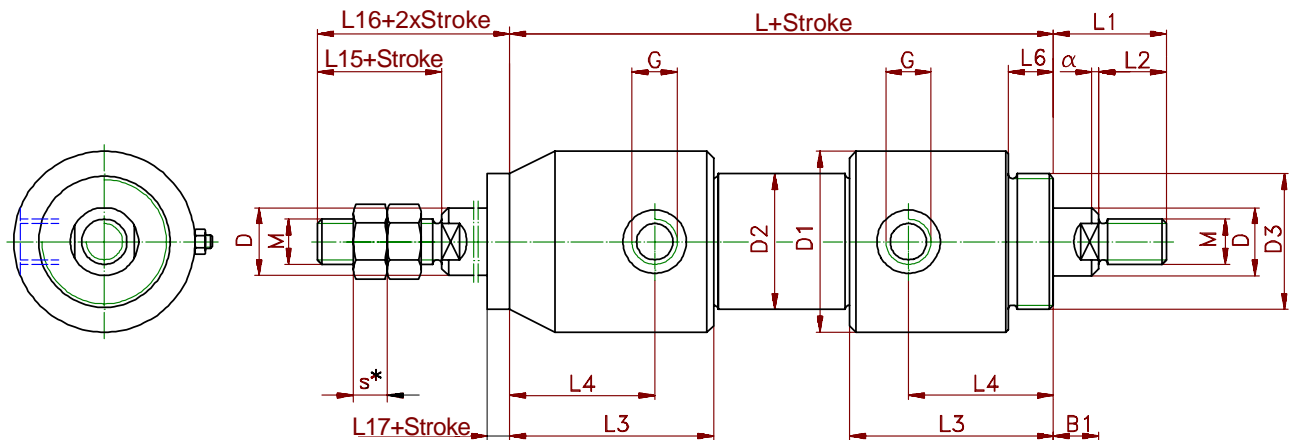

Functional modes

003 = double acting

004 = double acting with end-of-stroke damper on both sides

005 = double acting with end-of-stroke damper on rod side

006 = double acting with end-of-stroke damper on bottom side

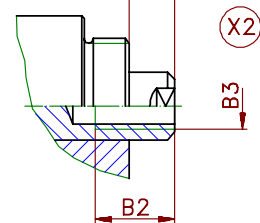
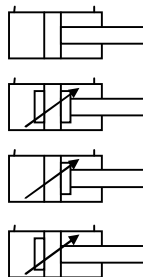

Piston rod end with female thread
Indicate desired size when ordering
Or according to customers drawing

The nondifferential cylinder can be combined with all other attachment methods!

Piston-ø	16	20	25	32	40	50	63	80	100	125	160	200
D rod ø	10	12	16	20	25	32	40	50	60	80	100	125
M	M8	M10	M14	M16	M20x1,5	M24x2	M30x2	M35x1,5	M45x1,5	M58x1,5	M80x2	M110x2
D1	32	37	45	50	64	75	95	115	140	180	225	280
D2	22	25	30	38	48	60	75	92	115	145	190	245
D3	M22x1,5	M32x1,5	M38x1,5	M42x1,5	M52x2	M60x2	M76x2	M92x2	M110x3	M155x3	M180x3	M200x3
L 003	80	107	133	139	153	168	210	237	257	322	420	460
L 004	100	137	173	179	193	218	260	297	327	402	520	580
L 005/006	90	122	153	159	173	193	235	267	292	362	470	520
L1	20	25	31	37	43	50	53	73	85	88	110	150
L2	12	15	20	22	25	30	33	48	60	58	80	110
L3	46	61	72	75	82	88	115	132	140	175	220	240
L4	23	35	44	45	49	52	70	84	92	113	145	145
L6	8	9	11	14	16	20	25	35	35	48	68	87
L15	20	20	25	30	35	45	55	60	70	80	100	140
L16	25	27	32	40	50	60	75	85	95	115	140	190
L17	10	12	12	15	20	25	30	35	40	50	60	70
s*	6,5	8	11	13	13	19	24	25	30	36	45	60
G	G1/8"	G1/8"	G1/4"	G1/4"	G3/8"	G1/2"	G1/2"	G1/2"	G1/2"	G3/4"	G1"	G1"
α	1x30°	1,5x30°	1,5x30°	2x30°	2x30°	2,5x30°	3x30°	3x30°	3x30°	4x30°	5x30°	6x30°

Design subject to change

Revision B.1 * 26.03.1997 *K.E.

Standard Cylinder Series SZ 250



Configuration 125

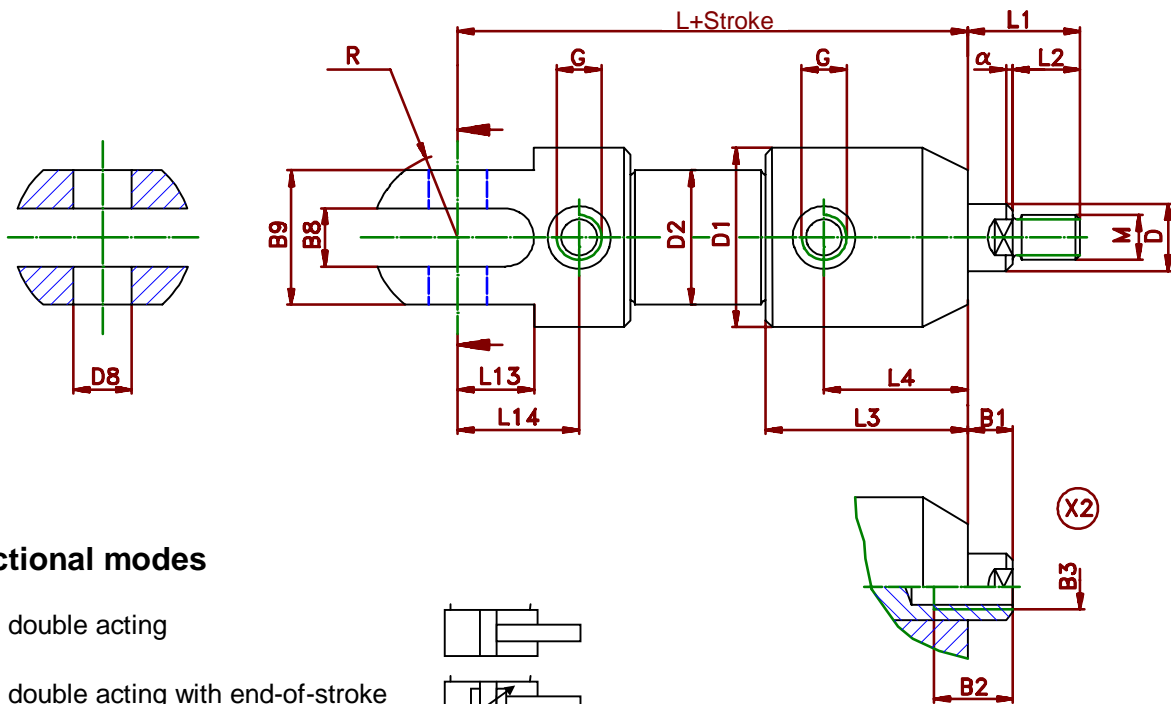

Functional modes

003 = double acting

004 = double acting with end-of-stroke damper on both sides

005 = double acting with end-of-stroke damper on rod side

006 = double acting with end-of-stroke damper on bottom side

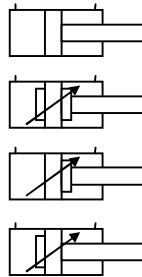

Piston rod end with female thread
Indicate desired size when ordering
Or according to customers drawing

Piston-ø	16	20	25	32	40	50	63	80	100	125	160	200
D rod ø	10	12	16	20	25	32	40	50	60	80	100	125
M	M8	M10	M14	M16	M20x1,5	M24x2	M30x2	M35x1,5	M45x1,5	M58x1,5	M80x2	M110x2
D1	32	37	45	50	64	75	95	115	140	180	225	280
D2	22	25	30	38	48	60	75	92	115	145	190	245
D8 H8	8	10	12	16	20	25	30	40	50	60	80	100
L 003	82	104	122	137	154	166	207	232	254	373	470	550
L 004	102	134	162	177	194	216	257	292	324	453	570	670
L 005/006	92	119	142	157	174	191	232	262	289	413	520	610
L1	20	25	31	37	43	50	53	73	85	88	110	150
L2	12	15	20	22	25	30	33	48	60	58	80	110
L3	46	61	72	75	82	88	115	132	140	175	220	240
L4	23	35	44	45	49	52	70	84	92	113	145	145
L13	15	20	24	28	33	37	52	65	75	141	170	210
L14	24	30	35	40	49	52	67	79	90	161	195	235
B8	8	10	12	16	20	25	30	40	40	50	60	70
B9	22	26	32	38	46	60	70	90	110	140	160	200
R	16	18,5	22,5	25	32	37,5	47,5	57,5	70	90	113	140
G	G1/8"	G1/8"	G1/4"	G1/4"	G3/8"	G1/2"	G1/2"	G1/2"	G1/2"	G3/4"	G1"	G1"
α	1x30°	1,5x30°	1,5x30°	2x30°	2x30°	2,5x30°	3x30°	3x30°	3x30°	4x30°	5x30°	6x30°

Design subject to change

Revision B * 15.11.1996 *K.E.

Standard Cylinder Series SZ 160

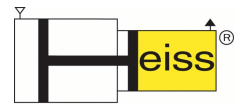

Configuration 225

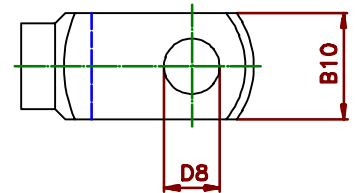
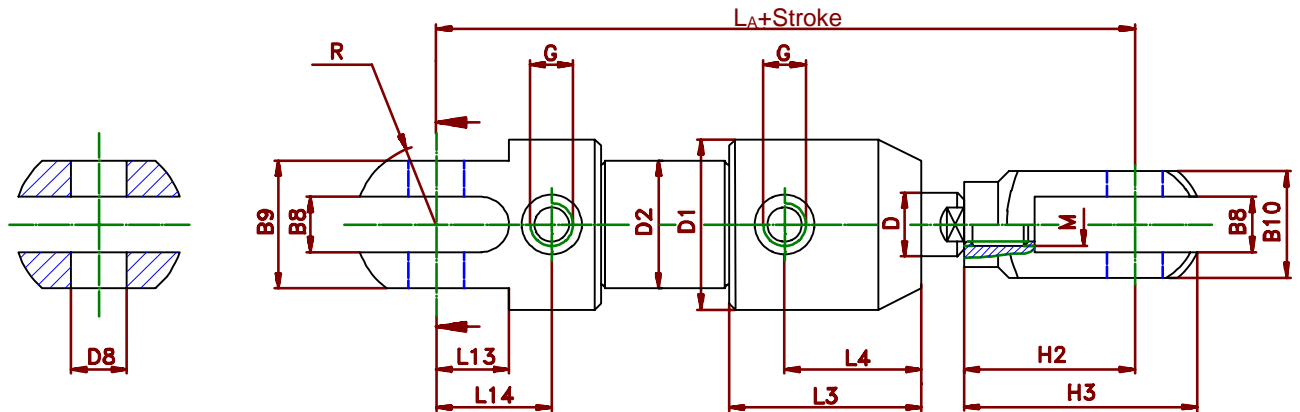

Functional modes

003 = double acting



004 = double acting with end-of-stroke damper on both sides

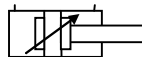

005 = double acting with end-of-stroke damper on rod side

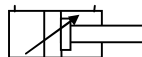

006 = double acting with end-of-stroke damper on bottom side

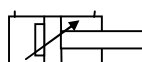

Piston-ø	16	20	25	32	40	50	63	80	100	125	160	200
D rod ø	10	12	16	20	25	32	40	50	60	80	100	125
M	M8	M10	M14	M16	M20x1,5	M24x2	M30x2	M35x1,5	M45x1,5	M58x1,5	M80x2	M110x2
D1	32	37	45	50	64	75	95	115	140	180	225	280
D2	22	25	30	38	48	60	75	92	115	145	190	245
D8 H8	8	10	12	16	20	25	30	40	50	60	80	100
LA 003	118	149	177	206	237	266	314	389	409	543	655	850
LA 004	138	179	217	246	277	316	364	449	479	623	755	970
LA 005/006	128	164	197	226	257	291	339	419	444	583	805	910
L3	46	61	72	75	82	88	115	132	140	175	220	240
L4	23	35	44	45	49	52	70	84	92	113	145	145
L13	15	20	24	28	33	37	52	65	75	141	170	210
L14	24	30	35	40	49	52	67	79	90	161	195	235
B8	8	10	12	16	20	25	30	40	40	50	60	70
B9	22	26	32	38	46	60	70	90	110	140	160	200
B10	16	20	24	32	40	50	55	85	100	130	150	200
H2	28	35	44	54	65	80	87	132	130	140	185	260
H3	38	47	58	73	90	112	125	196	195	210	260	360
R	16	18,5	22,5	25	32	37,5	47,5	57,5	70	90	113	140
G	G1/8"	G1/8"	G1/4"	G1/4"	G3/8"	G1/2"	G1/2"	G1/2"	G1/2"	G3/4"	G1"	G1"

Design subject to change

Revision B * 15.11.1996 *K.E.

Piston force diagram

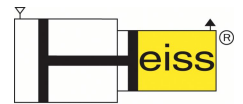

Formulas for calculation:

• of piston force on piston side: (pushing) $F = \frac{p \cdot D^2 \cdot \pi}{40000}$

• of piston force on rod side: (pulling) $F = \frac{p \cdot (D^2 - d^2) \cdot \pi}{40000}$

• of the required piston-Ø : $D_{\text{erf}} = \sqrt{\frac{F \cdot 40000}{p \cdot \pi}}$

• of the required operating pressure: $p_{\text{erf}} = \frac{F \cdot 40000}{\pi \cdot D^2}$

F ... piston force [kN]

p ... operating press. [bar]

D ... piston-Ø [mm]

d ... rod-Ø [mm].

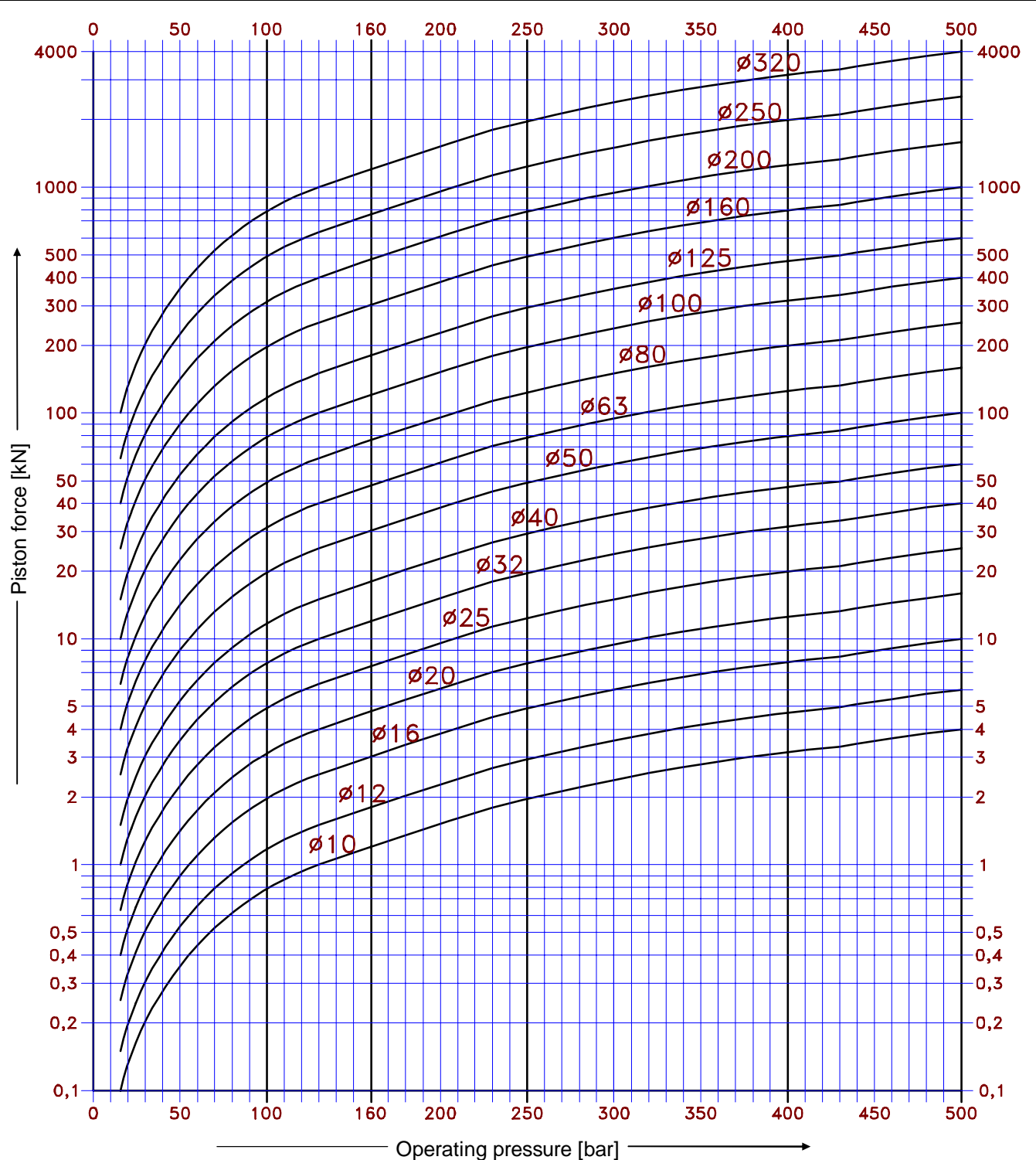

Revision B * 15.11.1996 *K.E.

Load/buckling diagram



		Loading case according to Euler								Rule of thumb for calculation:
		Case 1		Case 2		Case 3		Case 4		
Type of installation	Type of installation									$l_{kmax} = 4,51 \cdot \sqrt{\frac{d^4}{F}}$ $d_{erf} = 0,471 \cdot \sqrt[4]{l_k^2 \cdot F}$ $F_{max} = 20,35 \cdot \frac{d^4}{l_k^2}$ Safety factor $v = 5$ $E = 210000 \text{ N/mm}^2$
		111-2 117	110-1 111/111-1 112/112-1	116 218 / 219 225	114/114-1 115	111-2 117	110-1 111/111-1 112/112-1	111-2 117	110-1 111/111-1 112/112-1	
Config.		$l_k = 2 \cdot l$		$l_k = l$		$l_k = l \cdot \sqrt{0,5}$		$l_k = 0,5 \cdot l$		l_k buckling lgth [mm] d Rod- \emptyset [mm] F piston force [KN]

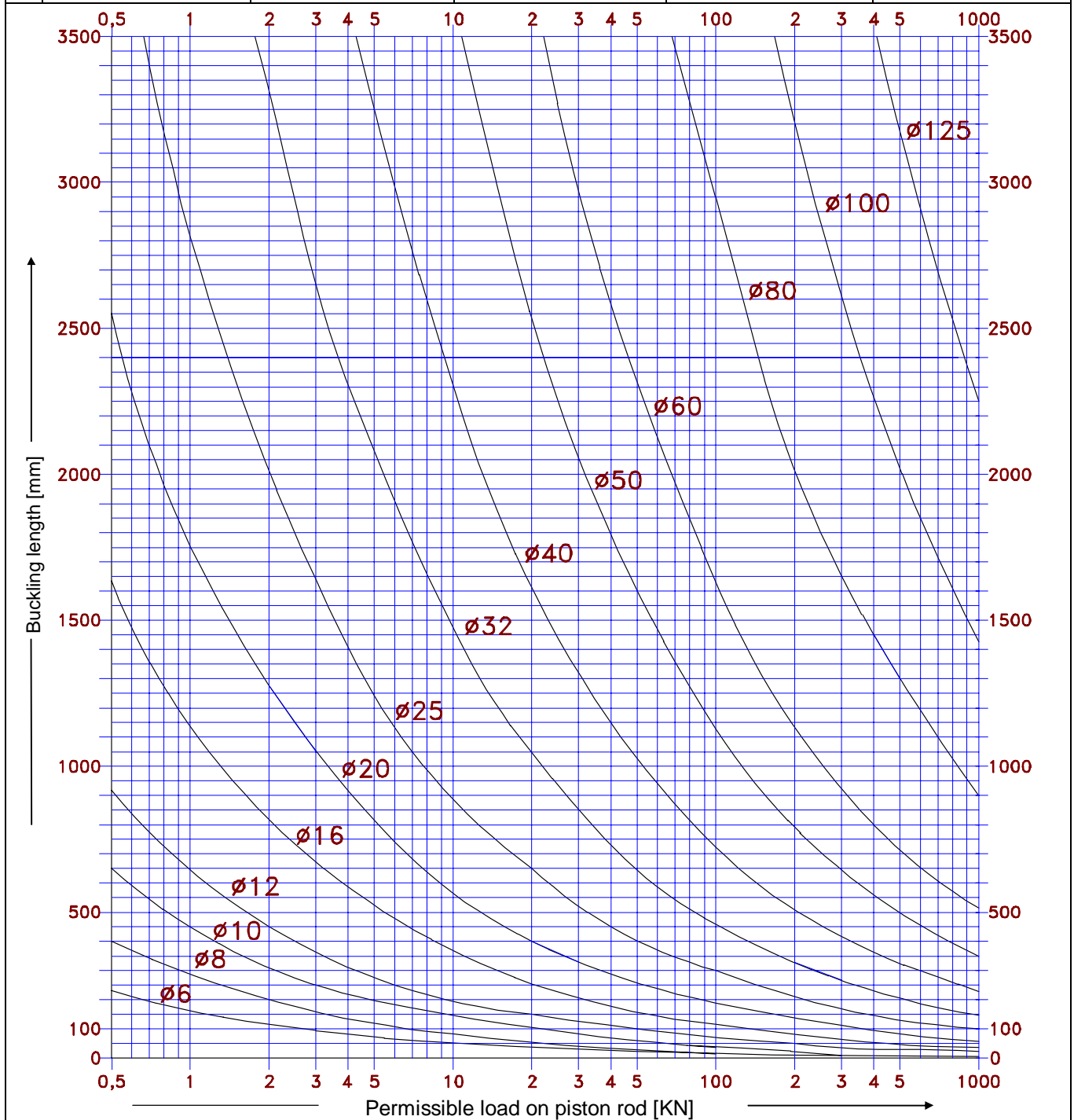

Revision B * 15.11.1996 *K.E.

Type designation



Description:

SZ 250 - 50 / 32 / 200 - 112 . 003 . X

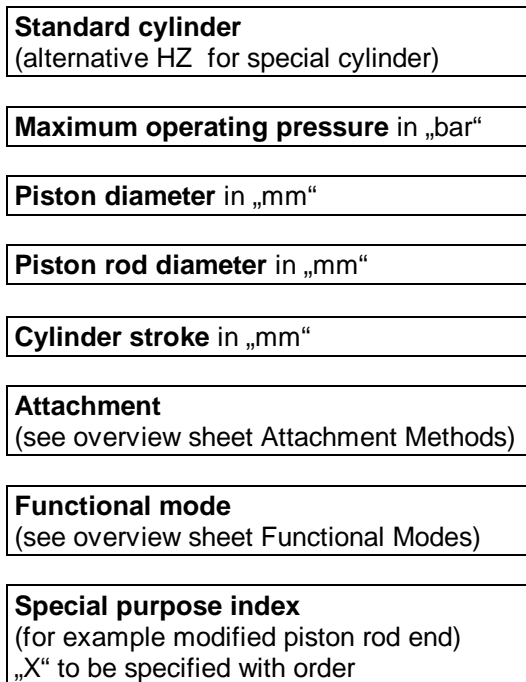

Examples for ordering:

SZ 250 - 32 / 16 / 85 - 117 . 003

Standard cylinder for operating pressure of 250 bar
 Piston diameter: 32 mm
 Piston rod diameter: 16 mm
 Cylinder stroke: 85 mm
 Flange attachment on bottom side
 Double acting

SZ 250 - 63 / 32 / 400 - 111 - 120 . 004

Standard cylinder for operating pressure of 250 bar
 Piston diameter: 63 mm
 Piston rod diameter: 32 mm
 Cylinder stroke: 400 mm
 Thread attachment
 Nondifferential cylinder
 Double acting with end-of-stroke damper on both sides

SZ 250 - 125 / 60 / 1200 - 115 . 006 . X2

L12 = 375

B1 = 40

B2 = 50

B3 = M 45x1,5

Standard cylinder for operating pressure of 250 bar
 Piston diameter: 125 mm
 Piston rod diameter: 60 mm
 Cylinder stroke: 1200 mm
 Pivot pin attachment at cylinder tube, distance from pivot pin center to cylinder head 375 mm
 Double acting with end-of-stroke damper on bottom side
 Piston rod with female thread M45x1,5; 50mm deep, piston rod excess end 40mm

Design subject to change	Revision B * 15.11.1996 *K.E.
--------------------------	-------------------------------